

UNIVERSAL COUNTER

MODEL 2201

PUBLICATION NO. 980857

RACAL INSTRUMENTS

United States

(Corporate Headquarters and Service Center)
4 Goodyear Street, Irvine, CA 92618
Tel: (800) 722-2528, (949) 859-8999; Fax: (949) 859-7139

5730 Northwest Parkway Suite 700, San Antonio, TX 78249
Tel: (210) 699-6799; Fax: (210) 699-8857

Europe

(European Headquarters and Service Center)
18 Avenue Dutartre, 78150 LeChesnay, France
Tel: +33 (0)1 39 23 22 22; Fax: +33 (0)1 39 23 22 25

29-31 Cobham Road, Wimborne, Dorset BH21 7PF, United Kingdom
Tel: +44 (0) 1202 872800; Fax: +44 (0) 1202 870810

Via Milazzo 25, 20092 Cinisello B, Milan, Italy
Tel: +39 (0)2 6123 901; Fax: +39 (0)2 6129 3606

Racal Instruments Group Limited, Technologie Park, D-51429 Bergisch Gladbach
Tel: +49 2204 844205; Fax: +49 2204 844219

info@racalinstruments.com
sales@racalinstruments.com
helpdesk@racalinstruments.com
<http://www.racalinstruments.com>
info@racalinstruments.de
www.racalinstruments.de



PUBLICATION DATE: December 02, 2004

Copyright 2000 by Racal Instruments, Inc. Printed in the United States of America. All rights reserved.
This book or parts thereof may not be reproduced in any form without written permission of the publisher.

THANK YOU FOR PURCHASING THIS RACAL INSTRUMENTS PRODUCT.

For this product, or any other Racal Instruments product that incorporates software drivers, you may access our web site to verify and/or download the latest driver versions. The web address for driver downloads is:

<http://www.racalinstruments.com/downloads>

If you have any questions about software driver downloads or our privacy policy, please contact us at

info@racalinstruments.com.

WARRANTY STATEMENT

All Racal Instruments, Inc. products are designed and manufactured to exacting standards and in full conformance to Racal's ISO 9000/2000 procedures.

This warranty does not apply to defects resulting from any modification(s) of any product or part without Racal Instruments express written consent, or misuse of any product or part. The warranty also does not apply to fuses, software, non-rechargeable batteries, damage from battery leakage, or problems arising from normal wear, such as mechanical relay life, or failure to follow instructions.

This warranty is in lieu of all other warranties, expressed or implied, including any implied warranty of merchantability or fitness for a particular use. The remedies provided herein are buyer's sole and exclusive remedies.

For the specific terms of your standard warranty, or optional extended warranty or service agreement, contact your Racal customer service advisor. Please have the following information available to facilitate service.

1. Product serial number
2. Product model number
3. Your company and contact information

You may contact your customer service advisor by:

E-Mail:	Helpdesk@racalinstruments.com	
Telephone:	+1 800 722 3262	(USA)
	+44(0) 8706 080134	(UK)
Fax:	+1 949 859 7309	(USA)
	+44(0) 1628 662017	(UK)

RETURN of PRODUCT

Authorization is required from Racal Instruments before you send us your product for service or calibration. Call your nearest Racal Instruments support facility. A list is located on the last page of this manual. If you are unsure where to call, contact Racal Instruments, Inc. Customer Support Department in Irvine, California, USA at 1-800-722-3262 or 1-949-859-8999 or via fax at 1-949-859-7139. We can be reached at: helpdesk@racalstruments.com.

PROPRIETARY NOTICE

This document and the technical data herein disclosed, are proprietary to Racal Instruments, and shall not, without express written permission of Racal Instruments, be used, in whole or in part to solicit quotations from a competitive source or used for manufacture by anyone other than Racal Instruments. The information herein has been developed at private expense, and may only be used for operation and maintenance reference purposes or for purposes of engineering evaluation and incorporation into technical specifications and other documents which specify procurement of products from Racal Instruments.

DISCLAIMER

Buyer acknowledges and agrees that it is responsible for the operation of the goods purchased and should ensure that they are used properly and in accordance with this handbook and any other instructions provided by Seller. Racal Instruments products are not specifically designed, manufactured or intended to be used as parts, assemblies or components in planning, construction, maintenance or operation of a nuclear facility, or in life support or safety critical applications in which the failure of the Racal Instruments product could create a situation where personal injury or death could occur. Should Buyer purchase Racal Instruments product for such unintended application, Buyer shall indemnify and hold Racal Instruments, its officers, employees, subsidiaries, affiliates and distributors harmless against all claims arising out of a claim for personal injury or death associated with such unintended use.

FOR YOUR SAFETY

Before undertaking any troubleshooting, maintenance or exploratory procedure, read carefully the **WARNINGS** and **CAUTION** notices.



CAUTION
RISK OF ELECTRICAL SHOCK
DO NOT OPEN



This equipment contains voltage hazardous to human life and safety, and is capable of inflicting personal injury.



If this instrument is to be powered from the AC line (mains) through an autotransformer, ensure the common connector is connected to the neutral (earth pole) of the power supply.



Before operating the unit, ensure the conductor (green wire) is connected to the ground (earth) conductor of the power outlet. Do not use a two-conductor extension cord or a three-prong/two-prong adapter. This will defeat the protective feature of the third conductor in the power cord.



Maintenance and calibration procedures sometimes call for operation of the unit with power applied and protective covers removed. Read the procedures and heed warnings to avoid “live” circuit points.

Before operating this instrument:

1. Ensure the proper fuse is in place for the power source to operate.
2. Ensure all other devices connected to or in proximity to this instrument are properly grounded or connected to the protective third-wire earth ground.

If the instrument:

- fails to operate satisfactorily
- shows visible damage
- has been stored under unfavorable conditions
- has sustained stress

Do not operate until, performance is checked by qualified personnel.

Racal Instruments

EC Declaration of Conformity

We

Racal Instruments Inc.
4 Goodyear Street
Irvine, CA 92718

declare under sole responsibility that the

2201 Universal Counter/Timer, P/N 407743-XXXXX

conforms to the following Product Specifications:

Safety: EN61010-1:1993+A2:1995

EMC: EN61326:1997+A1:1998

Supplementary Information:

The product herewith complies with the requirements of the Low Voltage Directive 73/23/EEC and the EMC Directive 89/336/EEC (modified by 93/68/EEC).

Irvine, CA, May 16, 2002

Engineering Director

This page was left intentionally blank.

Table of Contents

Chapter 1	1-1
GENERAL INFORMATION	1-1
Introduction.....	1-1
Manual Changes	1-2
Option.....	1-2
Safety Considerations	1-3
Supplied Accessories	1-3
Specifications	1-3
Front Panel Familiarization.....	1-3
Controls	1-4
Connectors	1-5
Display and Indicators	1-5
Rear Panel Familiarization.....	1-6
Connectors and terminals.....	1-7
Chapter 2	2-1
CONFIGURING THE INSTRUMENT	2-1
Introduction.....	2-1
Unpacking and Inspection	2-1
Performance Checks.....	2-1
Safety Precautions	2-2
Power Requirements.....	2-3
Grounding Requirements	2-3
Short Term Storage.....	2-4
Long Term Storage or Repackaging for Shipment.....	2-4
Installation	2-5
Chapter 3	3-1
USING the INSTRUMENT	3-1
Introduction.....	3-1
Power Up Procedure	3-1
Front Panel Reset	3-3
Display Messages	3-4
No Battery Error Message	3-4
GPIB Error Messages.....	3-4
Error Indication	3-5
Audible Alarm.....	3-5
Gate Error	3-5
Gate Time Error	3-6
Trigger Level Error	3-6
Control Selection.....	3-6
Selecting a Function.....	3-7
Selecting Gate or Delay Times.....	3-9

Setting the Trigger Level	3-11
Setting Input Conditioning Controls	3-12
Selecting the Number of Displayed Digits	3-14
Selecting the Measurement Rate	3-15
Arming	3-15
Continuous Arming with the Input Signal	3-16
Front Panel Arming	3-16
External (Rear Panel) Arming	3-16
Using the Auto Trigger Level	3-17
Using the V Peak A Function	3-17
Using the User Gate	3-18
Using the Delay	3-19
Using the User Delay	3-20
Using Front Panel Setups	3-20
How to Store Setups	3-21
How to Recall Setups	3-21
The Analog Output	3-22
Selecting the Analog output Resolution	3-22
Programming the Analog Output Offset	3-23
Using an External Reference	3-23
Changing the GPIB Address	3-23
Chapter 4	4-1
GPIB PROGRAMMING	4-1
Introduction	4-1
Bus Description	4-1
IEEE-488.1 Bus Lines	4-3
Bus Management Lines	4-4
Handshake Lines	4-4
Data Lines	4-5
Interface Function Codes	4-5
Software Considerations	4-6
Hardware Considerations	4-7
Typical Controller System	4-7
Connections	4-8
Changing GPIB Address	4-8
Bus Commands	4-10
Uniline Commands	4-11
Universal Multiline Commands	4-12
Addressed Commands	4-15
Unaddress Commands	4-16
Device Dependent Commands	4-16
Device-Dependent Command Programming	4-16
Function (F)	4-21
Coupling (AC,BC)	4-22
Channels A, B Attenuator (AA, BA)	4-22
Channels A, B Filter (AF, BF)	4-22
Channels A, B Slope (AS, BS)	4-23
Channels A, B Impedance (AI, BI)	4-23
Channels A, B Trigger Level (AL, BL)	4-23
Channels A, B Auto trigger level (L)	4-24

Gate Time (G, GU)	4-24
Delay Time (W, WU).....	4-24
Peak Measurement Rate (V)	4-25
Totalize Modes (M)	4-25
Displayed Digits (N)	4-25
Analog Output Resolution (P)	4-25
Analog Output Offset (O).....	4-26
Setup (ST, RE)	4-26
Triggering (T).....	4-26
Rate (S)	4-26
Display Modes (D)	4-27
SRQ Mode (Q) and Serial Poll Status Byte Format.....	4-27
Reading From the Instrument.....	4-29
Data Control Commands (R)	4-30
Terminator (Z).....	4-34
Prefix (X).....	4-35
Front Panel Error Messages	4-35
ILL INS (Illegal Instruction) Error	4-35
ILL PAR (Illegal Parameter) Error.....	4-35

Chapter 5	5-1
MAINTENANCE AND PERFORMANCE CHECKS	5-1
Introduction.....	5-1
Line Voltage Selection.....	5-2
Fuse Replacement	5-2
Using an External 10MHz Reference Input	5-3
Analog Output Option (Option 08).....	5-4
Disassembly Instructions.....	5-5
Special Handling of Static Sensitive Devices	5-5
Cleaning	5-6
Repair and Replacement.....	5-6
Performance Checks.....	5-6
Environmental Conditions.....	5-7
Warm-Up Period	5-7
Recommended Test Equipment	5-7
Performance Checks Procedure	5-8
Channel A and B Sensitivity Checks	5-8
Channel C Sensitivity Check	5-9
Period A, Period A Averaged Operation Check.....	5-10
Ratio A/B Operations Check.....	5-11
Pulse A, T.I A to B, Pules A Avg and T.I Avg Operation Check	5-12
Phase A to B Operation Check.....	5-14
Totalize B Operation Check.....	5-15
Auto Trigger Level A and B Operation Check.....	5-16
Delay Operation Check.....	5-17
User Gate Operation Check	5-18
Analog Output Operation Check.....	5-19
Time Base Accuracy Check.....	5-20

Chapter 6	6-1
ADJUSTMENTS	6-1
Introduction	6-1
Adjustments	6-1
Environmental Conditions	6-1
Warm-Up Period	6-1
Recommended Test Equipment	6-2
Adjustment Procedures	6-2
Adjustment Procedure	6-3
Power Supply Adjustment	6-3
Trigger Level A Adjustment	6-3
Trigger Level B Adjustment	6-5
Trigger Level A Offset Adjustment	6-5
Trigger Level B Offset Adjustment	6-6
Input A x10 High Frequency Adjustment	6-6
Input B x10 High Frequency Adjustment	6-7
TCXO Time Base Adjustment	6-7
Analog Output Adjustment (Option 08)	6-8
 Chapter 7	 7-1
PRODUCT SUPPORT	7-1
Product Support	7-1
Reshipment Instructions	7-1
Support Offices	7-2
 Appendix A	
MODEL 2201 SPECIFICATIONS	A-1

List of Figures

Figure 1-1 2201 Counter/Timer.....	1-1
Figure 1-2 Rear View of 2201	1-6
Figure 1-3 Rear View of 2201 with Option 12	1-6
Figure 4-1, IEEE Bus Configuration.....	4-2
Figure 5-1 2201 Counter/Timer.....	5-1
Figure 5-2 Reference Frequency and INT/EXT Clock Selection.	5-4
Figure 5-3 Channels A and B Sensitivity Test Set-up.....	5-8
Figure 5-4 Channel C Sensitivity Test Set-up.....	5-9
Figure 5-5 Period A and Period A Averaged Test Set-up.....	5-10
Figure 5-6 Ratio A/B Test Set-up.....	5-11
Figure 5-7 Pulse A, T.I A to B and Averaged Test Set-up.....	5-12
Figure 5-8 Phase A to B Test Set-up.....	5-14
Figure 5-9 Totalize B Test Set-up.....	5-15
Figure 5-10 Auto Trigger A and B Test Set-up.....	5-16
Figure 5-11 Delay Test Set-up.....	5-17
Figure 5-12 User Gate Test Set-up.....	5-18
Figure 5-13 Analog Output Test Set-up.....	5-19
Figure 5-14 Time Base Accuracy Test Set-up.....	5-20
Figure 6-1 Model 2201 Adjustment Point Locations	6-4

List of Tables

Table 3-1	Default States After Software Reset	3-3
Table 3-2	Front Panel Programming Limits	3-6
Table 3-3	Measuring Functions Summary	3-7
Table 3-4	Built-in Gate/Delay Intervals Summary	3-10
Table 4-1	Interface Function Codes.....	4-7
Table 4-2	IEEE-488.1 Contact Designation	4-9
Table 4-3	IEEE-488.1 Bus Commands Summary	4-10
Table 4-4	Default Conditions. (Status After SDC or DCL)	4-14
Table 4-5	Device-Dependent Command Summary	4-18
Table 4-6	SRQ Mask Commands	4-28
Table 4-7	SRQ Mask Legal Commands	4-28
Table 4-8	Status Byte Interpretation	4-28
Table 4-9	Data String Formats.....	4-32
Table 4-10	Status Word Interpretation.....	4-33
Table 5-1	Line Fuse Selection	5-3

Chapter 1

GENERAL INFORMATION

Introduction

This manual provides operating information for the Model 2201. Chapter 1 provides general information on the instrument. Chapters 2 and 3 contain installation and operating instructions. IEEE programming is explained in Chapter 4. Maintenance and performance checks are provided in Chapter 5 and Adjustments in Chapter 6.

The Model 2201 is a nine-digit, microprocessor based and fully programmable two-channel (with an optional third channel) Universal Counter Timer. The Model 2201 has 10 measurement functions: Frequency A, Frequency B, Frequency C (with Option 41), Period A, Rise/Fall Time A, Time interval A to B, Total count, Ratio A/B, Phase A to B and Peak Amplitude.

An averaging function is available for improved resolution in time measurement, resolving intervals to picoseconds. To simplify various repetitive tests, any of 10 pre-programmed complete set-up states, stored in a non-volatile memory, can be recalled by a simple key stroke, assuring exact duplication of previous setups no matter how complex.

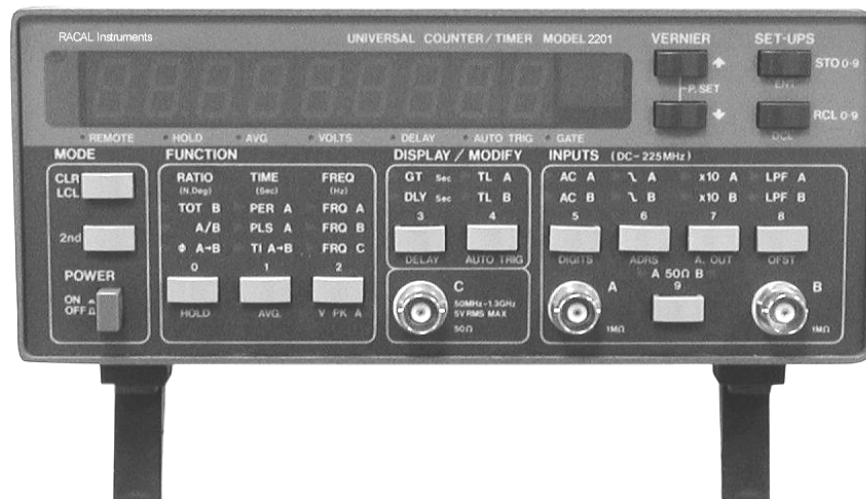

Figure 1-1 2201 Counter/Timer

The counter/timer utilizes combination of two measurement techniques in order to always achieve maximum measurement resolution. Up to nine digits of frequency measurements are displayed from as low as 0.1 Hz to more than 225 MHz. The reciprocal technique is used in low frequency measurements up to 10MHz; above this the measurement technique is changed to conventional measurement. The instrument measures frequency with a minimum resolution of eight digits in one second of gate time. Option 11 adds an ovenized compensated crystal oscillator (OCXO) for improved reading stability and accuracy. Option 12 adds a Rubidium oscillator for outstanding long-term stability and accuracy.

The traditionally featured decade steps of gate times are replaced by a more flexible variable gate time. This allows a choice of 50 internally pre-selected gate intervals or any external gate interval, which is applied to a rear panel BNC connector. The internal gate can be programmed from 100 μ s to 10 seconds. An external gate expands this range to 1000 seconds. The trigger level can be programmed manually or left to be automatically adjusted by the instrument to the optimum level, thus eliminating false triggering on unknown signals.

NOTE

This manual provides complete description for all features that are available for the Model 2201. It is possible that some options, which are described in the following paragraphs, are not installed in your instrument.

Manual Changes

Technical corrections to this manual (if any) are listed on the pages that they occur on with change date at the bottom of the page.

Option

There are several options available with the Counter: Options are factory installed only. Make sure you indicate at the time of the purchase which option you want supplied with your instrument.

Ordering Information		
Model	Description	Part Number
2201	225MHz Universal Counter/Timer (GPIB, TCXO)	407743-000
2201 w/Option 11	225MHz Universal Counter/Timer (GPIB, OCXO)	407743-XY1
2201 w/Option 12	225MHz Universal Counter/Timer (GPIB, Rubidium)	407743-XY2
2201 w/Option 08	225MHz Universal Counter/Timer (GPIB, Analog Output)	407743-X1Z
2201 w/Option 41	1.3GHz Universal Counter/Timer (GPIB)	407743-1YZ
Option 71	European Voltage/Power Cord	407789
Option 60A	19" Rack Mounting Kit	407745

Note: Option dash number positions, X, Y, and Z are available in any combination (-000 thru -112 are all valid)

Safety Considerations

The counter/timer has been manufactured according to international safety standards. The instrument meets CE, VDE 0411/03.81 and UL 3111-1 standards for safety and RFI radiation for commercial electronic measuring and test equipment, for instruments with an exposed metal chassis that is directly connected to earth via the chassis power supply cable.



WARNING

Do not remove instrument covers when operating or when the chassis power cord is connected to the mains.

Any adjustment, maintenance and repair of an opened, powered-on instrument should be avoided as much as possible, but when necessary, should be carried out only by a skilled person who is aware of the hazard involved.

Supplied Accessories

The Counter/Timer is supplied with an AC mains power cable and an user manual. A Maintenance Manual is available upon request.

Specifications

Model 2201 specifications are listed in Appendix A. These specifications are the performance standards or limits against which the instrument is tested. Specifications apply after 30 minutes of warm up time, and within a temperature range of 20°C to 30°C. Specifications outside this range are degraded by 0.1% per °C.

Front Panel Familiarization

A detailed functional description is given in the following paragraphs. The description is divided into logical groups: input and output connectors, operating modes, output type, output state, filters, synchronization, and front panel indicators.

The front panel is generally divided into three sections: controls, connectors, display and indicators. The following paragraphs describe the purpose of each of these items in details.

Controls

All front panel controls except POWER are momentary contact switches. Many controls include an annunciator light to indicate the selected mode. Controls, which do not have an annunciator light, when pressed, will cause an immediate reaction on the display. The controls are divided into functional groups for easier operation: power, mode, function, display modifier, inputs, venire and setups.

POWER - The POWER switch controls the AC power to the instrument. Pressing and releasing the switch once turns the power on. Pressing and releasing the switch a second time turns the power off.

MODE - There are two push buttons in the MODE section: clear/local and 2nd. The 2nd push-button is used to select secondary functions. All functions, which are marked on the panel with yellow, are associated with the 2nd function. Pressing the 2nd push-button will cause the instrument to display the following reading:

2nd ?

This reading is a blinking indication that the counter is ready for the press of a second push button which has a second function. Pressing the 2nd push button again will restore normal operation. The clear/local push-button, when pressed with the instrument in remote operation (but not in remote lockout condition LLO), restores local operation. When the instrument is in local operation, pressing this push-button clears the display and arms the counter for the next measurement cycle.

FUNCTION - The three FUNCTION push buttons control the measurement type. Each push button is used to select one of three functions.

FREQ. - The FREQ button places the instrument in one of three frequency measurement functions: Frequency A, Frequency B or Frequency C. Consecutive pressings of the FREQ button toggles between frequency A, Frequency B and Frequency C functions.

TIME - The TIME push button sets the timer up to measure one of three time measurement functions: Period A, Pulse A, or Time Interval A to B. Consecutive pressings of the TIME button toggles between these three functions.

RATIO - The RATIO push button places the instrument in one of three ratio measurement functions: Totalize B (infinite, by A or by AA), A/B or Phase A to B. Consecutive pressing of the FREQ button toggles between Totalize B, A/B and Phase A to B functions.

DISPLAY/MODIFY – The two DISPLAY/MODIFY push buttons modify the display from normal frequency, time or ratio reading to another reading such as trigger level, gate time, totalize mode, V peak mode or delay time.

INPUTS - There are 5 push buttons at the INPUTS section, which control the signal conditioning for Channels A and B. Push buttons control attenuation, coupling, slope, input impedance and low pass filter to suppress high frequency noise.

VERNIER - The two push buttons in the VERNIER section are used as a digital potentiometer. The VERNIER operates in conjunction with the following functions: Trigger level, Gate time, Delay time, Digits, GPIB Address, Totalize mode, Vpeak mode, Analog out, and Offset. The two push buttons also set these parameters to a known preset setting.

SETUPS - There are two push buttons in the SETUPS section. One is use to store a complete front panel set-up. The other button is used to recall a stored set-up.

Connectors

The connectors are used for connecting the instrument to the signal to be measured.

CHANNEL A - The CHANNEL A connector is used when making measurements that are related to channel A.

CHANNEL B - The CHANNEL B connector is used when making measurements that are related to channel B.

CHANNEL C - The CHANNEL C connector is used for high frequency measurements, up to 1.3 GHz. Although this connector is always installed, the internal circuitry behind this connector is optional (Option 41) and may not be installed in your instrument.

Display and Indicators

DISPLAY - The display shows the result of the processed measurement. The display is comprised of 9-digit mantissa and a single digit exponent. The exponent uses a leading minus to indicate negative values. The sign on the exponent changes to + for zero or positive values. The display is also used for indicating information other than the actual measurement, such as gate time or trigger-level settings.

INDICATORS - There are 30 indicators located on the front panel. The indicators are used as pointers to a selected function. Some of the indicators are used as indication that the instrument is set to display a non-measurement function, such as auto trigger or remote active.

Rear Panel Familiarization

The rear panel is generally divided into two sections: connectors and terminals. The following paragraphs describe the purpose of each of these items in details.



Figure 1-2 Rear View of 2201

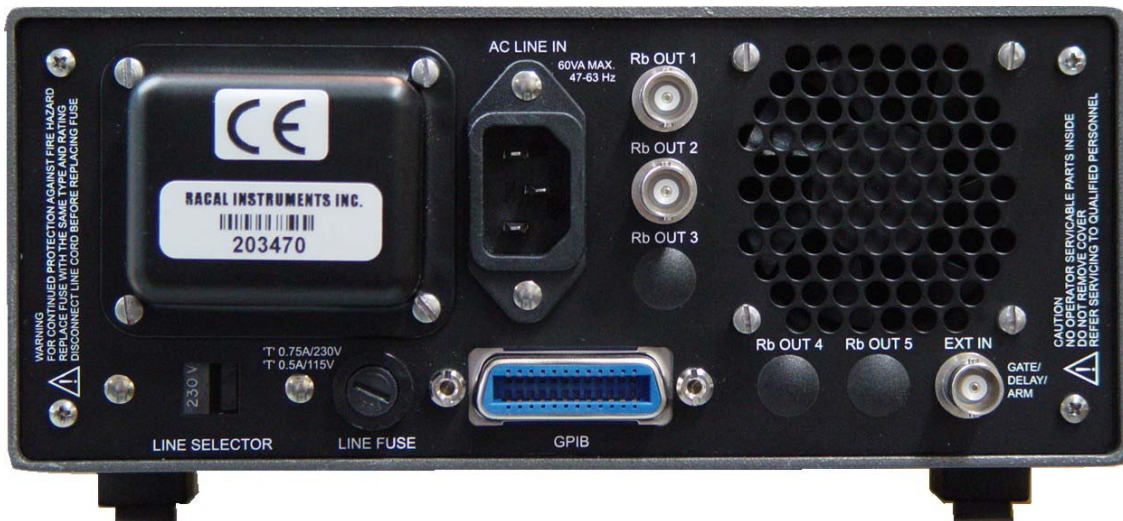

Figure 1-3 Rear View of 2201 with Option 12

Connectors and terminals

AC RECEPTACLE - Power is applied through the supplied power cord to the 3-terminal AC receptacle. Note that the selected power supply voltage is marked on the rear panel above the line voltage selector switch.

LINE SWITCH - The LINE VOLTAGE SELECTOR switch selects one of the primary voltages, which are marked on both sides of the switch.

LINE FUSE - The line fuse provides protection for the AC power line input. Always replace this fuse with the exact type and rating as specified on the rear panel.

IEEE-488 CONNECTOR - This connector is used for connecting the instrument to the GPIB bus.

TRIGGER LEVEL OUTPUTS (not available with Option 12) - These three terminals are used for monitoring the programmed DC level for channels A and B.

CLOCK (not available with Option 12) - This BNC connector is used as an internal clock output to be used as reference to other instruments. The same connector is used as input for an external reference. The function of this input/output is marked above the connector.

Rb OUT 1 (only available with Option 12) – 0 dBm sine wave output referenced to the internal Rubidium oscillator to be used as a reference for other instruments.

Rb OUT 2 (only available with Option 12) – AC MOS output referenced to the internal Rubidium oscillator to be used as a reference for other instruments.

EXT. ARMING/GATE/DELAY - A BNC connector that accepts one of three signals: arming pulse, external gate signal or external delay pulse. This input is useful when gate or delay times, other than the available internal intervals, are required.

ANALOG OUTPUT – An optional BNC connector (Option 08) that outputs a voltage, which is equivalent to the displayed readout. This voltage may then be connected to a chart recorder etc.

This page was left intentionally blank.

CONFIGURING THE INSTRUMENT

Introduction

This chapter contains information and instructions necessary to prepare the instrument for operation. Details are provided for initial inspection, power connection, grounding safety requirements, and repackaging instructions for storage or shipment, GPIB address selection and installation information.

Unpacking and Inspection



1. Remove the 2201 universal counter and inspect it for damage. If any damage is apparent, inform the carrier immediately. Retain shipping carton and packing material for the carrier's inspection.

2. Verify that the pieces in the package you received contain the correct 2201 universal counter and the 2201 universal counter Users Manual. Notify Racal Instruments if the universal counter appears damaged in any way.

3. The 2201 universal counter is shipped in an anti-static bag to prevent electrostatic damage to the module. Do not remove the universal counter from the anti-static bag unless it is in a static-controlled area.

Performance Checks

The instrument was carefully inspected for mechanical and electrical performance before shipment from the factory. It should be free of physical defects and in perfect electrical order upon receipt. Check the instrument for damage in transit and perform the electrical procedures outlined in Chapter 3. If there is indication of damage or deficiency, see the warranty in this manual and notify your local Racal field engineering representative or the factory.



CAUTION

It is recommended that the operator be fully familiar with the specifications and all sections of this manual. Failure to do so may compromise the warranty and the accuracy of your instrument.

Safety Precautions

The following safety precautions should be observed before using this product and associated computer. Although some instruments and accessories would normally be used with non-hazardous voltages, there are situations where hazardous conditions may be present.

This product is intended for use by qualified persons. These qualified personal recognize shock hazards and are familiar with the safety precautions required to avoid possible injury.

Be fully acquainted and knowledgeable with all aspects of this instruction manual before using the instrument to assure operator safety and protection against shock hazard.

Exercise extreme caution when a shock hazard is present. Lethal voltage may be present on cables, connector jacks, or test fixtures. The American National Standard Institute (ANSI) states that a shock hazard exists when voltage levels greater than 30V RMS, 42.4V peak or 60 VDC are present.

WARNING

For maximum safety, do not touch the product, test cables, or any other instrument parts while power is applied to the circuit under test. ALWAYS remove power from the entire test system before connecting cables or jumpers, installing or removing cards from the computer, or making internal changes such as changing the module address.

Do not touch any object that could provide a current path to the common side of the circuit under test or power line (earth) ground. Always keep your hands dry while handling the instrument.



When using test fixtures, keep the lid closed while power is applied to the device under test. Carefully read the Safety Precautions instructions that are supplied with your test fixtures.

Before performing any maintenance, disconnect the line cord and all test cables. Only qualified service personnel should perform maintenance.

Power Requirements

The instrument may be operated from any one of the following sources:

- a. 103.5 to 126.5 Volts (115 Volts nominal)
- b. 207 to 253 Volts (230 Volts nominal).

The instrument operates over the power mains frequency range of 48 to 63 Hz. Always verify that the operating power mains voltage is the same as that specified on the rear panel voltage selector switch.



CAUTION

Failure to switch the instrument to match the operating line voltage will damage the instrument and may void the warranty.

The instrument should be operated from a power source with its neutral at or near ground (earth potential). The instrument is not intended for operation from two phases of a multiphase AC system or across the legs of a single-phase, three-wire AC power system. Crest factor (ratio of peak voltage to rms) should be typically within the range of 1.3 to 1.6 at 10% of the nominal rms mains voltage.

Grounding Requirements

To ensure the safety of operating personnel, the U.S. O.S.H.A. (Occupational Safety and Health) requirement and good engineering practice mandate that the instrument panel and enclosure be "earth" grounded. The instrument is provided with a three-conductor power cable, which when plugged into an appropriate power receptacle, grounds the instrument. The long offset pin on the male end of the power cable carries the ground wire to the long pin of the Euro connector (DIN standard) receptacle on the rear panel of the instrument.

To preserve the safety protection feature when operating the instrument from a two-contact outlet, use a three-prong to two-prong adapter and connect the green lead on the adapter to an "earth" ground.



WARNING

Do not attempt to float the output from ground as it may damage the Model 2201 and your equipment.



CAUTION

To avoid operator shock hazard do not exceed the power mains voltage frequency rating which limits the leakage current between case and power mains. Never expose the instrument to rain, excessive moisture, or condensation.

Short Term Storage

If the instrument is to be stored for a short period of time, place cardboard over the panel and cover the instrument with suitable protective covering such as a plastic bag. Place power cable and other accessories with the instrument. Store the instrument in a clean dry area that is not subject to extreme temperature variations or conditions, which may cause moisture to condense on the instrument.

Long Term Storage or Repackaging for Shipment

If the instrument is to be stored for a long period of time or shipped immediately, proceed as directed below. If you have any questions, contact your local Racal Instruments Representative or the Racal Instruments Customer Service Department.

1. Repack the instrument using the wrappings, packing material and accessories originally shipped with the unit. If the original container is not available, purchase replacement materials.
2. Be sure the carton is well sealed with strong tape or metal straps.
3. Mark the carton with the model and serial number. If it is to be shipped, show sending and return address on two sides of the box.

NOTE

If the instrument is to be shipped to Racal Instruments for calibration or repair, attach a tag to the instrument identifying the owner. Note the problem, symptoms, and service or repair desired. Record the model and serial number of the instrument. Show the work authorization order as well as the date and method of shipment. ALWAYS OBTAIN A RETURN AUTHORIZATION NUMBER FROM THE FACTORY BEFORE SHIPPING THE INSTRUMENT TO RACAL INSTRUMENTS.

Installation

The instrument is fully solid state and dissipates only a small amount of power. No special cooling is required. However, the instrument should not be operated where the ambient temperature exceeds 50 °C, when the relative humidity exceeds 80% or condensation appears anywhere on the instrument. Avoid operating the instrument close to strong magnetic fields, which may be found near high power equipment such as motors, pumps, solenoids, or high power cables. Use care when rack mounting to locate the instrument away from sources of excessive heat or magnetic fields. Always leave 4 cm (1.5 inches) of ventilation space on all sides of the instrument.

This page was left intentionally blank.

Chapter 3

USING THE INSTRUMENT

Introduction

This chapter contains information about how to operate the instrument. Operation is divided into two general categories: basic bench operation, and IEEE-488 operation. Basic bench operation, which is covered in this chapter, describes how to use the counter/timer to perform basic frequency and time measurements. IEEE programming can also be used to greatly enhance the capability of the instrument in applications such as automatic test equipment. These aspects are covered in detail in Chapters 4 and 5.

Power Up Procedure

The basic procedure of powering up the Model 2201 is described below.

1. Connect the female end of the power cord to the Main AC receptacle on the rear panel. Connect the other end of the power cord to a grounded AC outlet.



CAUTION

Be sure the power line voltage agrees with the indicated value on the rear panel of the instrument. Failure to heed this warning may result in instrument damage.



WARNING

The instrument is equipped with a 3-wire power cord designed to be used with grounded outlets. When the proper connections are made, the instrument chassis is connected to the power line ground. Failure to use a properly grounded outlet may result in personal shock hazard.

2. Turn on the power by pressing and releasing the POWER switch on the front panel.
3. The instrument will then begin operation by performing a display and indicator test, which takes approximately one second. All mode and IEEE indicators will turn on and the display will appear as follows:

8.8.8.8.8.8.8.8. ±8

4. To verify that all display segments are operating, compare the instrument's display with the above during the test.
5. Following the display test, the instrument proceeds by displaying the options installed. When no option is installed, the instrument displays the following message:

2201-1

If option 08 (Analog Output) is installed, the instrument displays the following message:

2201-1.3

If option 41 (1.3GHz Input) is installed, the instrument displays the following message:

2201-1.2

For information or other installed options refer to the identification label on the rear of the instrument.

6. Once the model number and the installed options are displayed, the instrument will perform ROM and RAM tests. If all these tests are passed, the display shows the firmware revision level for about 1 second, similar to the example below:

SoFt 1.1

7. Following the software revision level, the instrument displays the GPIB address. The GPIB address is programmed using front panel sequences. The programmed address is stored in the non-volatile memory and remains active as long as backup battery power is available. For example, with address programmed to 25, the display shows:

IE Adr 25

8. Following these display messages, the instrument commences with normal operation and starts displaying readings. The instrument restores its last setup as was previously set before power shut down.

Front Panel Reset If you are not yet fully familiar with front panel operation of the instrument, it may appear to respond incorrectly to button presses. The fastest way to restore the counter to a known state is by resetting the instrument to factory defaults. Pressing the 2nd followed by the DCL buttons (second function to the RCL button) can do this. Following this sequence, the instrument will be then be set to its factory defaults. **Table 3-1** summarizes these conditions.

Table 3-1 Default States After Software Reset

Function	Default State
Function	Frequency A
Display/Modify	Normal reading
Gate/Delay Time	1 Sec
Trigger Levels A and B	0.00 V
Coupling	DC
Slope	Positive going Edge
Attenuator	Off
Filters	Off
Impedance	1 M Ω
Averaging	Off
Auto Trigger	Off
Delay	Off
Sampling Rate	Normal - 3 reading per second
V Peak A Measuring Rate	Fast
Totalize mode	Infinite
Displayed digits	9
Analog output	3 LSD
Analog output offset	0.00 V
GPIB Status	Local

NOTE

Software reset has no effect on any of the front panel setups that were previously stored in memory locations 0 through 9. The software reset also has no effect on the programmed GPIB address.

Display Messages

The instrument has several display messages associated with basic front panel operation. The instrument also has a few front panel indications that show an operating error associated with the front panel programming has been detected. These messages are discussed in the following. Note that the instrument has a number of additional display messages associated with IEEE-488 programming.

No Battery Error Message

The non-volatile memory stores 10 complete front panel setups. The same non-volatile memory, in case of power failure or upon regular power-up procedure, recalls the last front panel setup. The non-volatile memory is backed-up by a built-in battery, which should last approximately 3 years. Battery backup power loss will cause a loss of all pre-selected setups. In such cases, the instrument displays the following message:

no bAtt.

This message is displayed for about 2 seconds together with an audible alarm signal, indicating that the backup power test on the non-volatile memory has failed and that all previously programmed setups have been lost.

GPIB Error Messages

The instrument incorporates a number of display messages that are associated with GPIB programming errors. These messages are discussed in detail in Chapter 4 of this manual. However, there is one message, which should be explained at this time, because it may interfere with front panel operation. A remote enable or a device dependent command sent to the counter from a GPIB controller turns on the REMOTE light and automatically enables remote operation. In this case, all front panel controls, except the LCL button, are disabled. An attempt to press one of these buttons will cause the following message to display:

PrESS LcL

This message indicates that the instrument ignores front panel programming sequences unless the LCL push button is pressed and the REMOTE light turns off.

Error Indication

There are several error indications that are caused by either incorrect front panel programming or insufficient input level conditioning which is otherwise required by the instrument for normal signal processing. These indications are either visible (blinking LED) or audible (beeper) and are described in the following paragraphs.

Audible Alarm

The Audible Alarm sounds when performing an incorrect sequence of front panel programming. This could occur under the following conditions:

1. Any two front panel push buttons are pressed simultaneously except the two VERNIER push buttons.
2. The instrument is in a **FREQ**, **RATIO** or **TIME AVG** function and the operator attempts to turn the delay on.
3. The instrument is in a **FREQ** or **RATIO** function and the operator attempts to turn the **AVG** function on.
4. Option 08 (Analog Output) is not installed and the operator attempts to access parameters which are associated with the analog output function.
5. The instrument is in remote mode (**REMOTE LED** on) and any front panel push button (except **LCL**) is pressed.
6. The **VERNIER** push buttons were pressed and the instrument was not in the **DISPLAY/MODIFY** mode of operation.
7. The instrument was in the **DISPLAY/MODIFY** mode of operation and the **VERNIER UP** or **DOWN** push buttons were pressed continuously until a parameter limit was reached. Parameter limits are summarized in **Table 3-2**.

Gate Error

The gate error is indicated on the front panel by the **GT** light. Such an error occurs when the counter is in either the **FREQ** or **TIME AVG** function and when the signal was removed from the input connector in the middle of the measurement process. Due to the high sensitivity of the input circuit, it is also possible for this light to go on when radiated random noise is sensed by the input. The **GT LED** blinks once but no result is registered on the display.

Table 3-2 Front Panel Programming Limits

Button	Parameter	Low Limit	High Limit
TL A	Trigger Level A	- 5.00	+ 5.00
TL B	Trigger Level B	- 5.00	+ 5.00
GT	Gate Time	100 μ s	User Gate
DLY	Delay Time	100 μ s	User Delay
DIGITS	No of Displayed Digits	3	9
ADRS	GPIB Address	0	30
A. OUT	Analog Out Resolution	LSD	MSD
OFST	Analog out Offset	100	900

Gate Time Error

The gate time error is indicated on the front panel by the GT light. The gate time error occurs in **FREQ** or **TIME AVG** functions when the period of the input signal is larger than the period of the gate time. Gate time error also occurs in **phase A to B** function when the gate time is insufficient to measure the minimum resolution of 1° . When one of the conditions above occurs, the GT light blinks for a couple of times and then halts while the counter performs a search routine to find legal measurement conditions. This sequence repeats itself until a proper signal is found or until the gate time was readjusted to satisfy the required conditions.

Trigger Level Error

Trigger level error occurs when the instrument is set to **AUTO TRIG** or **V PEAK A** modes and the input signal is either absent or below the specified limits for auto trigger operation. The trigger level LED (either **TL A** or **TL B**) blinks for a couple of times and then halts while the counter performs a search routine to find legal measurement conditions. This sequence repeats itself until a proper signal is found or until the auto trigger mode was turned off.

Control Selection

Selecting the various front panel operating modes is simply a matter of pressing once or twice the appropriate button as described in the following paragraphs.

Selecting a Function

The instrument can be set up for the required measuring function using one of the three Function buttons. Sixteen different functions are available in the FUNCTION block as summarized in **Table 3-3**. To simplify the operating instructions for these functions, they are divided into three function groups.

The letter after the function indicates the input channel where this measurement is performed. For example, FREQUENCY C can only be measured if the signal is applied to the Channel C input connector. Similarly, V Peak A can only be measured at the Channel A input connector. Some functions require that both Channels A and B be connected for a successful measurement. For example: Time Interval A to B or Totalize B by A.

Table 3-3 Measuring Functions Summary

Function Group 1	Function Group 2	Function Group 3
Frequency A	Period Averaged A	Totalize B
Frequency B	Pulse Averaged A	Totalize B
Frequency C	T.I Averaged A to B	V Peak A (Fast Gate)
Period A		V Peak A (Slow Gate)
Pulse A		
Time Interval A to B		
Totalize B (infinitely)		
Ratio A/B		
Phase A to B		

Selecting a function from the first group is described in the following paragraphs:

First reset the instrument to a known state by pressing in sequence the 2nd and then the DCL push button. The instrument defaults to a factory pre-selected state and the light next to FRQ A illuminates; indicating that the **Frequency A** function is now selected.

To select **Frequency B** press the FREQ button once. The light next to FRQ B illuminates indicating that the Frequency B function is now selected.

To select **Frequency C** press the FREQ button again. The light next to FRQ C illuminates; indicating that Frequency C is now selected. Note that this procedure assumes that option 41 (1.3GHz Channel C is installed).

To select **Period A** press the TIME push button once. The light next to PER A illuminates indicating that the Period A is now selected.

To select **Pulse A**, press the TIME button again. The light next to PLS A illuminates indicating that the Pulse A function is now selected.

To select **Time Interval A to B** press the TIME push button again. The light next to TI A to B illuminates indicating that the Time Interval A to B is now selected.

To select **Totalize B** press the RATIO button once. The light next to TOT B illuminates indicating that Totalize B is now active.

To select **Ratio A/B** press the RATIO button again. The light next to A/B illuminates indicating that Ratio A/B is now selected.

To select **Phase A to B** press the RATIO button again. The light next to Phase A to B illuminates indicating that Phase A to B is now selected.

Selecting a function from the second group is described in the following paragraphs:

To select **Period Averaged A** press the TIME push button until the light next to PER A illuminates. Press the 2nd button and then press the AVG button (second function to the TIME button). Observe that the AVG light illuminates indicating that the Period Averaged A function is now selected.

To select **Pulse Averaged A** press the TIME button until the light next to PLS A illuminates. Press the 2nd button and then press the AVG button (second function to the TIME button). Observe that the AVG light illuminates indicating that the Pulse Averaged A function is now selected.

To select **Time Interval Averaged A to B** press the TIME button until the light next to TI A to B illuminates. Press the 2nd button and then press the AVG push-button (second function to the TIME button). Observe that the AVG light illuminates indicating that the Time Interval Averaged A to B function is now selected.

NOTE

The averaging function, once selected, will automatically turn on whenever a TIME measuring function is selected. For example, Selecting PER A averaged turns the AVG light on. Changing the selected function to FRQ A will turn the AVG light off. Re-selecting one of the TIME functions will automatically turn the AVG light back on.

Selecting a function from the third group requires additional operations and is described in the following paragraphs:

To select the **Totalize B by A** function, press the RATIO button until the light next to TOT B illuminates. The counter is now set to totalize indefinitely. To select the Totalize B by A function press the GT push button in the DISPLAY/MODIFY group and observe that the reading on the display is as follows:

tot InF

This reading indicates that the instrument is set to Totalize infinitely. Now press the VERNIER UP push button once and observe that the display reading is changed to the following:

Tot bY A

This reading indicates that the instrument is now set to Totalize events at the B input with A serving as the gating signal. Press the GT button again. The instrument is now ready to perform the required function.

To select the **Totalize B by AA** function, repeat the procedure as described above. Pressing the VERNIER UP button will change the display reading as follows:

Tot bY AA

This reading indicates that the instrument is now set to Totalize events at the A input with a pair of transitions at A, having the same direction, serving as the gating signal. Press the GT button again. The instrument is now ready to perform the measurement.

The **V Peak A** function has two measurement rates: Fast, for frequencies above 100 Hz and Slow, for frequency ranges of 40 Hz to 10 MHz. Note that the instrument, after DCL defaults to Fast rate. Selecting the measurement rate for this function is described later in this manual.

Selecting Gate or Delay Times

The counter/timer makes available 46 pre-defined gate or delay intervals. Factory default is 1 second for both gate and delay times. When selecting the gate time, the instrument will move up or down one gate time increment each time the UP or DOWN button is pressed. The programmed gate time can be observed on the display by pressing the GT/DLY push-button.

Gate times may be selected only in conjunction with frequency, time averaged, ratio A/B and Phase A to B measurements.

Program a gate time value using the following procedure:

1. Select a frequency measurement function.
2. Press the GT/DLY button. The GT light turns on and the instrument displays the following message:

The reading indicates the selected gate time in seconds.

3. To change the gate time, press the VERNIER UP or DOWN push buttons. Pressing the UP button increases the gate time. Conversely, pressing the DOWN button decreases the gate time. Continuous press of the Up or Down buttons causes the instrument to increment or decrement continuously.
4. Pressing the UP button when the instrument displays a gate time of 10 seconds forces the instrument into USER GATE mode. This mode requires an external gating signal. Using the counter with an external gate is explained later in this chapter.
5. Pressing the UP and DOWN simultaneously changes the gate time to a preset value of 1 second.
6. To resume normal display operation, press the GT/DLY button. The GT light turns off and the instrument is now ready to perform measurements with the newly selected gate time. **Table 3-4** lists the Gate/Delay Times, which are available internally for the user.

Table 3-4 Built-in Gate/Delay Intervals Summary

100 μ s	1 ms	10 ms	100 ms	1 ms	1 s	10 s
200 μ s	2 ms	20 ms	200 ms	2 ms	2 s	User Gate
300 μ s	3 ms	30 ms	300 ms	3 ms	3 s	User Delay
400 μ s	4 ms	40 ms	400 ms	4 ms	4 s	
500 μ s	5 ms	50 ms	500 ms	5 ms	5 s	
600 μ s	6 ms	60 ms	600 ms	6 ms	6 s	
700 μ s	7 ms	70 ms	700 ms	7 ms	7 s	
800 μ s	8 ms	80 ms	800 ms	8 ms	8 s	
900 μ s	9 ms	90 ms	900 ms	9 ms	9 s	

NOTE

To prevent operator error, there is an internal audible alarm that sounds whenever a limit is reached, (e.g. low limit of 100 μ s).

The delay time may only be selected in conjunction with non-averaged time measurement.

To select the delay time proceed as follows:

1. Select a non-averaging time measurement function.
2. Press the GT/DLY button. Observe that the DLY light turns on and the instrument displays the following message:

1

This reading indicates the selected delay time in seconds.

3. To change the delay time, press the VERNIER UP or DOWN push buttons. Pressing the UP button increases the delay time. Conversely, pressing the DOWN button decreases the delay time. Holding in the Up or Down buttons continuously, causes the instrument to increment or decrement continuously.
4. Pressing the UP button when the instrument is set for a delay time of 10 seconds forces the instrument into a USER DELAY mode. This mode requires an external delay signal. Operating the counter with an external delay is explained later in this section.
5. Pressing the UP and DOWN simultaneously changes the delay time to a preset value of 1 Sec.
6. To resume normal display operation, press the GT/DLY button. The DLY light turns off and the instrument is now ready to perform measurements with the newly selected delay time. **Table 3-4** lists the Gate/Delay Times, which are available internally for the user.

Setting the Trigger Level

There is a trigger level push button associated with Channel A (TL A) and Channel B (TL B). The VERNIER push buttons, when operated in conjunction with TL A or TL B, set the threshold level that triggers the instrument.

To set the trigger level, use the procedure below.

NOTE

The procedure for setting the trigger level is identical for Channels A and B. Access to TL A is possible only one of the functions that is associated with the A input are active. Selecting a function that is associated with the B input enables access to TL B.

1. Set the instrument to Frequency A measurement or reset the counter using the Firmware Reset procedure, as described earlier in this chapter.

2. Press the TL A button. The TL A and VOLTS indicators illuminate and the display reads as follows:

0.00

The reading indicates the selected trigger level in units of volts.

3. To program a positive trigger level, press the VERNIER UP button. Pressing the UP or DOWN push buttons continuously causes the instrument to increment or decrement continuously. To set a negative trigger level press the VERNIER DOWN button until the desired level is displayed.
4. Simultaneously press the two VERNIER push buttons and note that the display reading resets to 0.
5. Press the TL A button. The indicator light turns off and the instrument returns to its previous measurement state.
6. To set the trigger level for both Channels A and B, select a function which involves both inputs (e.g. ratio A/B, ϕ A to B, time interval A to B or totalize B by A). Pressing the TL button once will turn the TL A light on indicating that the instrument displays the trigger level for Channel A. A consecutive press turns the TL B light on indicating that the instrument displays the trigger level for Channel B. A third push turns the TL B light off. The instrument then resumes normal operation.

Setting Input Conditioning Controls

Proper setting of the input controls ensures correct measurements and operation of the counter. There are five push buttons that set up the input. These buttons are common to both Channels A and B.

Changing one of the input setting controls is simply a matter of pressing the required button. There are 5 lights for each input channel, which are associated with each of the five controls.

To set input condition controls for Channel A proceed as follows:

1. Set the instrument to operate at one of the following functions: FRQ A, PER A, PLS A or V Peak A.
2. To select the required coupling mode, press the AC button. Coupling is DC when the light is off. When the light is on the coupling is AC.
3. To change the trigger slope, press the SLOPE button. If the light is off then the counter will trigger on the positive edge of the input signal. If the light is on then the counter will trigger on the negative going edge.

4. When the signal exceeds the specified dynamic range of the input, attenuation is required. To attenuate the signal, press the x10 button. The input signal is attenuated by a factor of 10 when the light is on. When the light is off, the input signal is not attenuated.
5. For low frequency measurements where the frequency range is below 100kHz, the use of a filter is recommended to attenuate high frequency signals which may interfere with the measurement. To apply a low pass filter press the LPF button. Filter is applied when the light is on. The filter is not active when the light is off.
6. The use of 50 Ω termination is recommended when measuring frequencies above 1MHz. The use of such termination is also recommended for measuring signals having high slew rates. By default, the input impedance is set to 1M Ω . To change the input impedance to 50 Ω , press the 50 Ω button. Termination is 50 Ω when the light is on and 1M Ω when the light is off.

To set the input condition controls for Channel B proceed as follows:

1. Set the instrument to operate in one of the following functions: FRQ B or TOT B.
2. Use the same procedure as described above for Channel A.

To set input condition controls for both Channels A and B proceed as follows:

1. Set the instrument to operate in one of the following functions: Time Interval A to B, Ratio A/B, ϕ A to B, TOT B by A or TOT B by AA.
2. To select AC coupled mode for Channel A, press the AC button once. The AC A light illuminates, indicating that Channel A is now AC coupled. Pressing the AC push-button again turns the AC A light off and turns the AC B light on, indicating that Channel A is DC coupled and Channel B is AC coupled.
3. Pressing the button once more, turns both AC A and AC B light on; indicating that both channels are now ac coupled. Pressing the same button again turns both lights off, indicating that both channels are set to DC coupled mode.
4. Use the same procedure to set the slope, attenuation, impedance and filtering.

Selecting the Number of Displayed Digits

A major advantage of the counter is its capability to display a fixed number of digits regardless of the frequency of the measured signal. For example, with one second of gate time, the instrument can display 8 digits. This however, may turn out to be a disadvantage when measuring the frequency of a relatively unstable signal in which the most significant digits are stable and the least significant digits are "jumping around" with no significant meaning. The counter can be programmed to truncate the unstable least significant digits and display only the digits of interest. To select the number of displayed digits proceed as follows:

1. Press the 2nd button. The instrument prompts with the following message:

2nd ?

2. Press the DIGITS button (second function to AC A). The instrument now displays the following:

x diGit

Where x is the selected number of digits and could range from 3 to 9 digits.

- 3 Use the VERNIER UP to increase the number of displayed digits. Conversely, press the VERNIER DOWN to decrease this number.
- 4 Pressing the VERNIER UP and DOWN buttons simultaneously presets x to 9.
- 5 To return to normal operation, simply press and release the ENT button (second function to STO). The instrument now displays the processed measurement with the newly selected number of digits.

NOTE

Selecting five digits to be displayed instead of nine eliminates the four least significant digits and shifts the entire display to the right by four places. Under certain conditions, it is possible that the counter will display less than nine digits. This may occur when the selected gate time is very small. In that case, the instrument overrides the function of the selected number of digits and displays only as many digits as it can. When gate time is increased, the instrument again limits the number of displayed digits to the selected value.

Selecting the Measurement Rate

There are three measurement rates that are available for the user. Only two measurement rates are accessible through the front panel: Normal rate of about 3 readings per second and single cycle (hold). The third measurement rate can be accessed through GPIB programming only and will be discussed in further details in Chapter 4.

Refer to the front panel HOLD indicator: The HOLD light determines the rate of measurement. When the indicator is off, the instrument is in set to normal measurement rate. To select a different measurement rate proceed as follows:

1. Press the 2nd button and then press the HOLD button (second function to RATIO). The HOLD light turns on indicating that the instrument is now armed for single-shot measurement cycles. Arming is explained later in this chapter.
2. To return to the normal measurement rate, press the 2nd button and then the HOLD button. The HOLD light turns off, indicating that the instrument is now set to accept and process readings at normal rates.



NOTE

The measurement rate is gate time dependent. The counter can process 3 readings in one second only if the gate time is set to 300 ms or below.

Arming

The arming feature allows a measurement to be taken only when a valid signal is present at the Ext. Input connector. The instrument can operate in one of four arming options:

1. In normal operating mode, the inputs are continuously armed to process measurements on valid input signals.
2. In HOLD mode (single-shot measurement) the operator arms the input by pressing the front panel CLR button.
3. In HOLD mode (single-shot measurement) the operator arms the input by applying an arming pulse to the rear panel EXT. INPUT connector.
4. Arming can also be executed through GPIB programming.

Information how to arm the inputs over the GPIB is given in Chapter 4 of this manual. The following paragraphs describe front and rear panel arming in detail.

Continuous Arming with the Input Signal

When the instrument is not in the hold mode and there is no signal present at the input connector, the instrument stays in the idle state with the gate light off. A valid input signal that crosses the programmed threshold level initiates a measurement cycle. The gate light flashes every time the internal gate opens. There is no special procedure to set the instrument up for continuous arming.

Front Panel Arming

Front panel arming is done with the CLR push-button. To use front panel arming perform the following steps:

1. Select the hold mode using the procedure described above. Observe that the HOLD light is on and the gate light goes off. This state indicates that the counter is in one-shot mode. The display reading is zero and no reading is processed until an arming stimulant is applied.
2. To trigger a single reading, press and release the CLR button. The instrument is ready to take and process the next measurement.
3. To arm the instrument for a new measurement, press the CLR button again. The display reading will zero and a new measurement will be processed.
4. To remove the instrument from the one-shot arming mode, turn the hold function off by pressing, in sequence, the 2nd and HOLD push buttons.

External (Rear Panel) Arming

External arming operates much like front panel arming except that the arming stimulus is applied to the rear panel EXT INPUT connector. The arming pulse must have TTL levels. To use external arming, proceed as follows:

1. Select the hold mode using the procedure described above. Note that the GATE light is off, indicating that the instrument is in one-shot mode. The display reading is zero and no reading is processed until an arming stimulus is applied.
2. Connect an external arming source to the rear panel EXT INPUT connector. The first positive going transition at the EXT INPUT connector arms the counter for the next front panel signal. Note that after each positive going transition of the arming signal, the numeric display is set to read zero until the next data is processed and displayed. The instrument ignores any transitions at the EXT INPUT connector while the gate is open and the counter is processing measurements.
3. To remove the instrument from the one-shot arming mode, turn the hold function off using the procedure described above.

Using the Auto Trigger Level

The auto trigger function is useful when measuring repetitive signals having an unknown DC component. The auto trigger is capable of finding the peaks of the signal and then setting the trigger level at exactly the center. In addition, the auto trigger automatically sets the correct attenuation to adjust the input signal to the operating dynamic range. The auto trigger mode will not operate with the totalize B and frequency C functions. To set the instrument to operate in auto trigger mode, proceed as follow:

1. Press the 2nd button and then press AUTO TRIG. The AUTO TRIG light illuminates, indicating that the auto trigger function is active. When the indicator is off, the instrument is operating in manual trigger level mode.
2. Apply the signal to be measured to the appropriate input connector. After a short search sequence, the gate opens and the measurement is processed.
3. TL A or TL B blinks if an error was detected.
4. To return to normal trigger level mode, press the 2nd button and then the AUTO TRIG button.

Using the V Peak A Function

Using the V PEAK function turns the instrument into a versatile RF peak voltage meter where both low and high peaks are detected, processed and displayed. This is especially useful in analyzing the amplitude of the signal and the magnitude of the DC component. There are two available measurement rates for the V Peak function: Fast rate, for normal measurements above 100Hz and slow rate, for the measurement of signals below 100Hz. To select the V Peak function proceed as follows:

1. Press the 2nd button and then the V PK A button (second function to FREQ). Observe that the VOLTS light illuminates, indicating that the instrument is set to V Peak A measurement. The normal display reading transforms into a two-section display like the following:

0.00 0.00

The three digits on the left indicate the low peak value. The right three digits indicate the high peak. Minus signs and decimal points are automatically displayed.

2. To select the measurement rate, press the GT button in the DISPLAY/MODIFY group and observe that the reading on the display is as follows:

FASt

This reading indicates that the instrument is set to the fast measuring rate. Now press the VERNIER UP push button once and observe that the display reading is changed to the following:

SLO

This reading indicates that the instrument is set to V Peak A with a slow measuring rate. Press the GT button again. The instrument is now ready to perform the required function.

3. Press the GT button to return the counter to normal V Peak display.
4. Press one of the FUNCTION push buttons to select another function. The display returns to normal display reading and the VOLTS light turns off.

Using the User Gate

The user gate is useful when a gate time other than the predetermined gate times that are listed in **Table 3-4** are required. The limits that must be observed are the minimum limit of 100 μ seconds and the maximum limit of 1000 seconds. The user gate function is accessible in FRQ A, B and C, A/B, PER AVG, PLS AVG and TI AVG A to B operating modes. To operate the instrument in the user gate mode proceed as follows:

1. Set the instrument to FRQ A. Press the GT button and observe that the GT light turns on and the instrument displays the gate time.
2. Press and hold the VERNIER UP push button and observe that the display increments. After the 10 seconds gate time the instrument displays the following readout:

USER GAtE

Pressing the UP button after the user gate is displayed will cause the audible alarm to sound.

3. Press the GT button. The light turns off and the instrument is ready for measurements with an external gate time.
4. Apply a TTL pulse to the rear panel EXT INPUT connector. The high level duration of the TTL pulse determines the length of the gate time.
5. To exit the user gate function, press the VERNIER DOWN button. Pressing both the UP and DOWN push buttons simultaneously presets the gate time to 1 second.

Using the Delay

The Model 2201 has a delay function that prevents the closure of the opened gate for a predetermined period as listed in **Table 3-4**. This function is very useful in burst measurements, relay open/close time measurements where bounce time should be eliminated, or in measurements done on a train of pulses. The delay function is accessible in PER A, PLS A, and Time Interval A to B. The delay time may be selected as follows:

1. Set the instrument to PER A measurement. Press the DLY button in the DISPLAY/MODIFY group and observe that the DLY light turns on and the instrument displays the delay time.
2. To change the delay time, press the VERNIER UP or DOWN push buttons. When one of the UP or DOWN buttons are pressed for more than one second, the instrument increments or decrements continuously.
3. Pressing the VERNIER UP and DOWN simultaneously changes the delay time to a preset value of 1 second.
4. To resume normal display, press the DLY button. The DLY light turns off. When enabled, the instrument performs measurements with the newly selected delay time. **Table 3-4** lists the delay times that are available as defaults.
5. To enable the delay mode, press the 2nd button and then the DELAY button (second function to GT/DLY). Observe that the DELAY light illuminates, indicating that the instrument is now set to operate in delay mode. A selection of any other function, when DELAY light is on, automatically turns off the delay light. Conversely, returning to one of these functions again enables the delay mode.
6. To return to normal operation press the 2nd button and then the GT/DLY button. The DELAY light turns off, indicating that the instrument is no longer in delay mode.

Using the User Delay

The user delay is useful when a delay time other than the predetermined delay times that are listed in **Table 3-4** are required. The limits that must be observed are the minimum limit of 100 μ seconds and the maximum limit of 1000 seconds. The user delay function is accessible in PER A, PLS A, and Time Interval A to B operating modes. To operate the instrument in the user delay mode proceed as follows:

1. Set the instrument to PER A. Press the DLY button and observe that the DLY light turns on and the instrument displays the delay time.
2. Press and hold the VERNIER UP button and observe that the display increments. After the 10 seconds delay time the instrument displays the following readout:

USER dLAY

3. To resume normal display, press the DLY button. The DLY light turns off. When enabled, the instrument performs measurements with the user delay time.
4. To enable the user delay mode, press the 2nd button and then the DELAY button (second function to GT/DLY). Observe that the DELAY light illuminates, indicating that the instrument is now set to operate in the user delay mode. A selection of any other function when the DELAY light is on will automatically turn off the delay light. Conversely, returning to one of these functions again enables the user delay mode.
5. Apply a TTL high pulse to the rear panel EXT INPUT connector. Delay would then be enabled as long as this input is kept at a TTL high level. The first negative transition to a TTL low at this input disables the delay. The delay would then be disabled as long as this input is kept at a TTL low.

Using Front Panel Setups

Setting up all parameters for a versatile instrument such as a counter/timer takes some time. Setup time is even longer when more than one set-up is required. The instrument incorporates a battery backed-up, non-volatile memory that preserves stored information for 3 years, typical. It is possible to store complete front panel settings in 10 different memory locations for later use with a simple key stroke.

How to Store Setups

First modify the front panel parameters as necessary to perform your measurement. When all parameters are set and checked, proceed to save and store this setup as follows:

1. Press the STO button and observe that the display is modified to indicate the following:

StorE ?

The “?” appears flashing. This reading indicates that the instrument is ready to receive the memory location where front panel setup is to be stored. Setups may be stored in locations 0 through 9. Pressing STO again cancels this function and the instrument resumes normal operation.

2. Select one memory location from 0 to 9 and press the button which is marked with the desired number. The instrument then displays the following for one second:

StorE D

where “D” is the selected memory location. This display indicates that the instrument acknowledges that it has stored the front panel settings into the displayed memory location. The instrument then resumes normal operation.

How to Recall Setups

Turning the AC power off does not have an affect on the stored settings that have been previously stored by the user. To recall a front panel setup proceed as follows:

1. Press the RCL button and observe that the display is modified to indicate the following:

rEcALL ?

The “?” appears flashing. This reading indicates that the instrument is ready to recall front panel setup from one of the memory locations. Pressing the RCL button cancels this function and the instrument resumes normal operation.

2. Select a memory location from 0 to 9 and press the button that is marked with the selected number. The instrument displays the following for one second:

rEcALL D

where “D” is the selected memory location. The instrument then recalls the parameters that were previously stored in the selected memory cell and updates front panel indicators with the recalled parameters.

The Analog Output

The analog output option (Option 08) provides a high accuracy source to drive devices like chart recorders. This option is especially useful in measuring and recording the long term stability of oscillators, V-to-F converters, temperature drifts, etc. Front panel programming allows the selection of any three adjacent digits, which are then monitored by the instrument and applied to the analog output as a DC voltage equivalent to three digit reading. Full-scale output is +9.99 V. A 000 display reading is equivalent to 0.00 V at the output connector and a reading of 999 is equivalent to 9.99 V.

Selecting the Analog output Resolution

First set up the instrument to the required function, gate time and input conditioning as described earlier in this chapter. Make sure that the required resolution is displayed. For an example, assume that the display reading is as follows:

1.23456789 E+3

Also assume that we want to monitor the 3rd, 4th and 5th digits from the right, as underlined above. To program the instrument to convert just these three digits to an equivalent DC voltage proceed as follows:

1. Press the 2nd button and then the A.OUT button (second function to SLOPE). The display reading changes to display a group of three bars as follows:

_____789 E+3

The least significant digits 7,8 and 9 are shown as whole digits. These digits are converted for the analog output. The rest of the digits are replaced by horizontal bars.

2. Press the VERNIER UP or DOWN push buttons to move the digits from left to right and vice versa until the display indicates the following:

___456___ E+3

3. Press the ENT button to program the instrument for the selected resolution.
4. Connect a BNC cable from the analog output connector to the chart recorder. The analog output will be updated about 100ms after it completes a measurement cycle. The output then follows the readings on the display.

Programming the Analog Output Offset

Front panel programming allows the addition of an offset to the analog output voltage so that the needle on the chart recorder can rest anywhere between the bottom and the top of the scale. To set the analog output offset, proceed as follows:

1. Press the 2nd button and then press the OFST button (second function to LF). The VOLTS indicator will turn on and the display reading will be as follows:

xxx (xxx could range from 100 to 900)

This reading indicates the offset voltage that would be applied to the analog output reading. 100 indicates 1 V, 900 indicates 9 V.

2. Press the VERNIER UP or DOWN buttons to change the offset reading.
3. Press both VERNIER UP and DOWN buttons to reset the offset reading to 0 V.
4. Press the ENT button (second function to STO) to program the instrument to the new offset value. The counter will then return to a normal display reading.

Using an External Reference

There are three accuracy grades available for the counter, they are: the Temperature Compensated Crystal Oscillator (TCXO), the Ovenized Compensated Crystal Oscillator (OCXO), or the Rubidium Oscillator. The TCXO accuracy, over the specified temperature operating range is 1 PPM. The OCXO accuracy, over the specified temperature operating range is 0.01 PPM. The Rubidium accuracy, over the specified temperature operating range is 0.001 PPM. For applications where accuracy needs to be better than the internal oscillator, an external reference may be applied. An EXT REF connector is available on the rear panel unless the Rubidium option is present. However, before applying the reference signal, it is first necessary to open the top cover and change a switch setting. The procedure for changing this switch is given in Chapter 5.

Changing the GPIB Address

The GPIB address can be modified using front panel programming. The non-volatile memory stores the GPIB address. A conventional address switch is not provided. Detailed instructions of how to change the GPIB address are given in Chapter 4.

This page was left intentionally blank.

Chapter 4

GPIB PROGRAMMING

Introduction

The IEEE-488 bus is an instrumentation data bus with standards adopted by the IEEE (Institute of Electrical and Electronic Engineering) in 1975 and given the IEEE-488.1 designation. The most recent revision of bus standards was made in 1978; hence the complete description for current bus standards is the IEEE-488.1-1978 designation. The instrument conforms to the IEEE-488.1, 1978 standards.

This section contains general bus information as well as detailed programming information and is divided as follows:

1. General introductory information pertaining to the IEEE-488.1 bus may be found primarily in the paragraph "Bus Description".
2. Information necessary to connect the instrument to the bus and to change the bus address is contained in the paragraph "Hardware Considerations".
3. Programming of the instrument with general bus command is covered in the paragraph "Bus Commands".
4. Device-dependent command programming is described in detail in the paragraph "Device-Dependent Command Programming". The commands outlined in this section can be considered to be the most important since they control virtually all instrument functions.
5. Additional information pertaining to front panel error messages and controller programs can be found in the paragraph "Front Panel Error Messages".

Bus Description

The IEEE-488.1 bus was designed as a parallel data transfer medium to optimize data transfer without using an excessive number of bus lines. In keeping with this goal, the bus has only eight data lines, which are used for both data and most commands. Five bus management lines and three handshake lines round out the complement of signal lines. Since the bus is of parallel design, all devices connected to the bus have the same information available simultaneously. Exactly what is done with the information by each device depends on many factors, including device capabilities.

A typical bus configuration for remote controlled operation is shown in **Figure 4-1**. The typical system will have one controller and one or more instruments to which commands are given and from which data is received. There are three categories that describe device operation. These include controller, talker and listener.

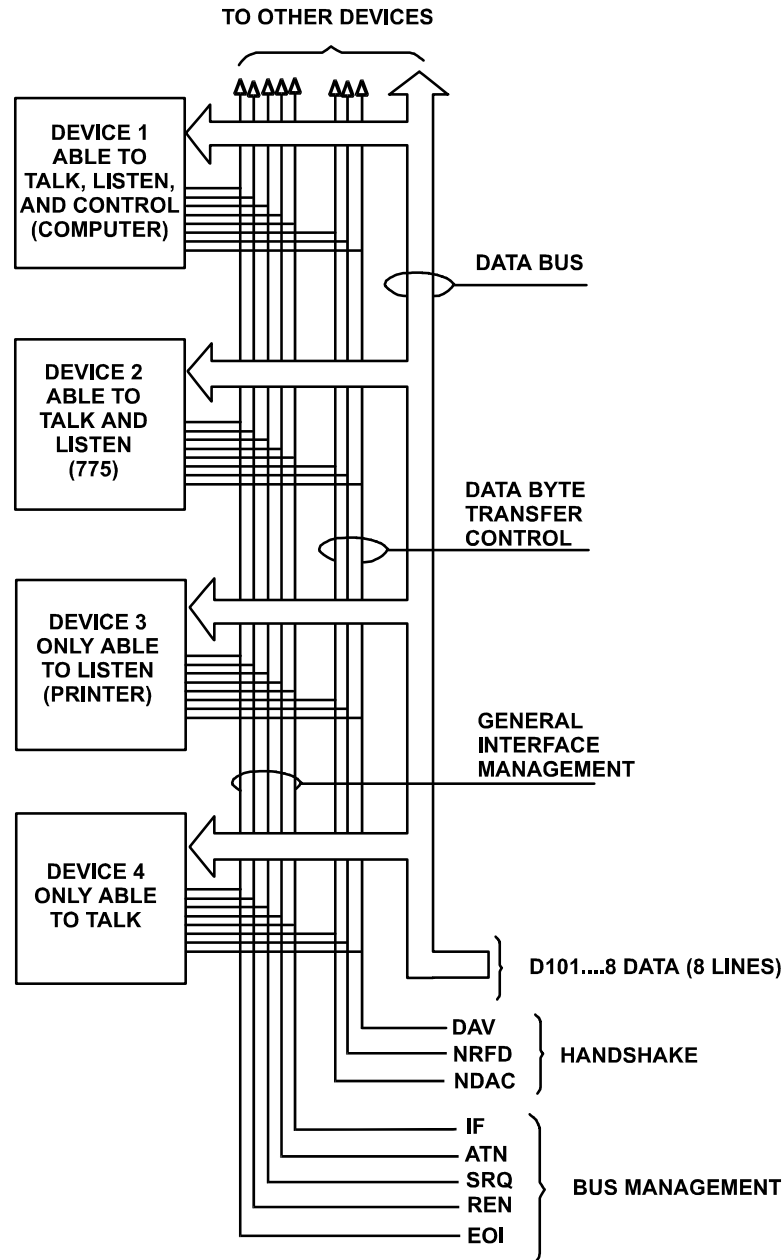

Figure 4-1 IEEE Bus Configuration

The controller controls other devices on the bus. A talker sends data, while a listener receives data. An instrument, may be a talker only, a listener only, or both a talker and listener.

Any given system can have only one controller (control may be passed to an appropriate device through a special command). Any number of talkers or listeners may be present up to the hardware constraints of the bus. The bus is limited to 15 devices, but this number may be reduced if higher than normal data transfer rates are required or if long interconnect cables are used.

Several devices may be commanded to listen at once, but only one device may be a talker at any given time

Before a device can talk or listen, it must be appropriately addressed. Devices are selected on the basis of their primary address. The addressed device is sent a talk or listen command derived from its primary address. Normally, each device on the bus has a unique primary address so that each may be addressed individually. The bus also has another addressing mode called secondary addressing, but not all devices use this addressing mode.

Once the device is addressed to talk or listen, appropriate bus transactions may be initiated. For example, if an instrument is addressed to talk, it will usually place its data on the bus one byte at a time. The listening device will then read this information.

IEEE-488.1 Bus Lines

The signal lines on the IEEE-488 bus are grouped into three general categories. The data lines handle bus information, while the handshake and bus management lines assure that proper data transfer and bus operation takes place. Each of the bus lines is "active low" so that approximately zero volts is logic "one". The following paragraphs describe the purpose of these lines.

Bus Management Lines

The bus management group is made up of five signal lines that provide orderly transfer of data. These lines are used to send the uniline commands described in the paragraph "Uniline Commands".

1. ATN (Attention) - The state of the ATN line determines whether controller information on the data bus is to be considered data or a multiline command.
2. IFC (Interface Clear) - Setting the IFC line true (low) causes the bus to go to a known state.
3. REN (Remote Enable) - Setting the REN line low sends the REN command. This sets up instruments on the bus for remote operation.
4. EOI (End Or Identify) - The EOI line is used to send the EOI command that usually terminates a multi-byte transfer sequence.
5. SRQ (Service Request) - the SRQ line is set low by a device when it requires service from the controller.

Handshake Lines

The bus uses three handshake lines that operate in an interlocked sequence. This method assures reliable data transfer regardless of the transfer rate. Generally, data transfer will occur at a rate determined by the slowest active device on the bus.

One of the handshake lines is controlled by the data source, while the remaining two lines are controlled by accepting devices. The three bus handshake lines are:

1. DAV (Data Valid) - The source controls the state of the DAV line.
2. NRFD (Not Ready For Data) - the acceptor controls the state of the NRFD line.
3. NDAC (Not Data Accepted) - the acceptor also controls the NDAC line.

The complete handshake sequence for one data byte is as follows:

Once data is on the bus, the source checks to see that NRFD is high, indicating that all devices on the bus are ready for data. At the same time NDAC should be low from the previous byte transfer. If these conditions are not met, the source must then wait until the NRFD and NDAC lines have the correct status. If the source is controller, NRFD and NDAC must remain stable for at least 100 ns after ATN is set low. Because of the possibility of bus hang up, some controllers have time-out routines to display error messages if the handshake sequence stops for any reason.

Once the NRFD and NDAC lines are properly set, the source sets the DAV line low, indicating that data on the bus is now valid. The NRFD line then goes low; the NDAC line goes high once all devices on the bus have accepted the data. Each device will release the NDAC line at its own rate, but the NDAC line will not go high until the slowest device has accepted the data byte.

After the NDAC line goes high, the source then sets the DAV line high to indicate that the data on the bus is no longer valid. At this point, the NDAC line returns to its low state. Finally, the NRFD line is released by each of the devices at their own rates, until the NRFD line finally goes high when the slowest device is ready, and the bus is set to repeat the sequence with the next data byte.

The sequence just described is used to transfer both data and multiline command. The state of the ATN line determines whether the data bus contains data or commands.

Data Lines

The IEEE-488 bus uses the eight data lines that allow data to be transmitted and received in a bit-parallel, byte-serial manner. These eight lines use the convention DI01 through DI08 instead of the more common D0 through D7 binary terminology. The data lines are bi-directional and, as with the remaining bus signal lines, low is true.

Interface Function Codes

The interface function codes are part of the IEEE-488.1-1978 standards. These codes define an instrument's ability to support various interface functions and should not be confused with programming commands found elsewhere in this manual.

Table 4-1 lists the codes for the instrument. The numeric value following each one or two letter code define the counter's capability as follows:

SH (Source Handshake Function) - The ability for the instrument to initiate the transfer of message/data on the data bus provided by the SH function.

AH (Acceptor Handshake Function) - The ability for the instrument to guarantee proper reception of message/data on the data bus provided by the AH function.

T (Talker Function) - The ability of the counter to send device-dependent data over the bus (to another device) is provided by the T function. Model 2201 talker capabilities exist only after the instrument has been addressed to talk.

L (Listen Function) - The ability of the instrument to receive device-dependent data over the bus (from another device) is provided by the L function. The listener function capability of the instrument exists only after it has been addressed to listen.

RS (Service Request Function) - The ability of the instrument to request service from the controller is provided by the RS function.

RL (Remote-Local Function) - The ability of the counter to be placed in remote or local modes is provided by the RL function.

PP (Parallel Poll Function) - The ability of the counter to respond to a parallel poll request from the controller is provided by the PP function.

DC (Device Clear Function) - The ability for the counter to be cleared (initialized) is provided by the DC function.

DT (Device Trigger Function) - The ability of the counter to have its output triggered is provided by the DT function.

C (Controller Function) - The counter does not have a controller function.

TE (Extended Talker Capabilities) - The counter does not have extended talker capabilities.

LE (Extended Listener Function) - The counter does not have extended listener function.

Software Considerations

The most sophisticated computer in the world would be useless without the necessary software. This basic requirement is also true of the IEEE-488.1 bus, which requires the use of handler routines as described in this paragraph. Before a controller can be used with the IEEE-488.1 interface, the user must make certain that appropriate handler software is present within the controller.

From the preceding discussion, the message is clear: make sure the proper software is being used with the instrument. Often, the user may incorrectly suspect that a hardware problem is causing fault, when it was the software that was causing the problem all along.

Table 4-1 Interface Function Codes

Code	Interface Function
SH1	Source Handshake Function
AH1	Acceptor Handshake Capabilities
T6	Talker (basic talker, serial poll, unaddressed to talk on LAG)
L4	Listener (basic listener, unaddressed to listen on TAG)
SR1	Service request capability
RL1	Remote/Local capability
PP2	Parallel Poll capability
DC1	Device Clear capability
DT1	Device Trigger capability
C0	No controller capability
E1	Open collector bus drivers
TE0	No Extended Talker capabilities
LE0	No Extended Listener capabilities

Hardware Considerations

Before the instrument can be used with the IEEE-488.1 bus, it must be connected to the bus with a suitable cable. Also, the primary address must be properly programmed as described in this chapter.

Typical Controller System

The IEEE-488.1 bus is a parallel interface system. As a result, adding more devices is simply a matter of using more cables to make the desired connections. Because of this flexibility, system complexity can range from simple to extremely complex.

The simplest possible controlled system comprises a controller and one instrument. The controller is used to send commands to the instrument, which sends data back to the controller.

The system becomes more complex when additional instruments are added. Depending on programming, all data may be routed through the controller, or it may be transmitted directly from one instrument to another.

Connections

The instrument is connected to the bus through an IEEE-488.1 connector. This connector is designed to be stacked to allow a number of parallel connections on one instrument.



NOTE

To avoid possible mechanical damage, it is recommended that no more than three connectors be stacked on any one instrument. Otherwise, the resulting strain may cause internal damage to the connectors.

NOTE

The IEEE-488.1 bus is limited to a maximum of 15 devices, including the controller. Also, the maximum cable length is 20 meters. Failure to observe these limits will probably result in erratic bus operation.

Custom cables may be constructed using the information in **Table 4-2**. **Table 4-2** also lists the contact assignments for the various bus lines. Contacts 18 through 24 are return lines for the indicated signal lines, and the cable shield is connected to contact 12. Each ground line is connected to digital common in the counter.



CAUTION

The voltage between IEEE common and ground can not exceed 0V or damage may result to your instrument.

Changing GPIB Address

The primary address of your instrument may be programmed to any value between 0 and 30 as long as the selected address is different from other device addresses in the system. This may be accomplished using a front panel programming sequence. Note that the primary address of the instrument must agree with the address specified in the controller's program.

NOTE

The programmed primary address is briefly displayed during the power-up cycle of the instrument. It is stored in the non-volatile memory of the instrument and is retained even when power is turned off.

To check the present address, or to enter a new one, proceed as follows:

1. Press the 2nd button once then press the ADR button (second function to SLOPE). The display is modified to show the following:

IE Adr x

Where x may be any number from 0 to 30.

2. Press the VERNIER UP or DOWN push buttons the select a new GPIB address.

3. To store the newly selected primary address press ENT (second function to STO). The instrument resumes normal operation.

Table 4-2 IEEE-488.1 Contact Designation

Contact Number	GPIB Contact Designation	Type
1	DIO1	Data
2	DIO2	Data
3	DIO3	Data
4	DIO4	Data
5	EOI	Management
6	DAV	Handshake
7	NRFD	Handshake
8	NDAC	Handshake
9	IFC	Management
10	SRQ	Management
11	ATN	Management
12	SHIELD	Ground
13	DIO5	Data
14	DIO6	Data
15	DIO7	Data
16	DIO8	Data
17	REN	Management
18-24	Ground	Ground

Bus Commands

While the hardware aspect of the bus is essential, the interface would be worthless without appropriate commands to control the communications between the various instruments on the bus. This paragraph briefly describes the purpose of the bus commands, which are grouped into the following three categories:

1. Uniline commands: Sent by setting the associated bus lines low.
2. Multiline commands: General bus commands which are sent over the data lines with the ATN line low (true).
3. Device-dependent commands: Special commands that depend on device configuration sent over the data lines with ATN high (false).

Table 4-3 IEEE-488.1 Bus Commands Summary

Command Type	Command	State of ATN Lines	Comments
Uniline	REN	X	Set up for remote operation
	EOI	X	Sent by setting EOI low
	IFC	X	Clears Interface
	ATN	Low	Defines data bus contents
	SRQ	X	Controlled by external device
Multiline Universal	LLO	Low	Locks out front panel controls
	DCL	Low	Reset device to default conditions
	SPE	Low	Enable serial polling
	SPD	Low	Disables serial polling
Addressed	SDC	Low	Reset device to default conditions
	GTL	Low	Returns to local control
	GET	Low	Triggers device for reading
Unaddressed	UNL	Low	Removes all listeners from bus
	UNT	Low	Removes all talkers from bus

Uniline Commands

Uniline commands are sent by setting the associated bus line to low. Only the system controller asserts the ATN, IFC, and REN commands. The SRQ command is sent by an external device. Either the controller or an external device depending on the direction of data transfer may send the EOI command. The following is description of each command.

REN (Remote Enable) - The remote enable command is sent to the instrument by the controller to set the instrument up for remote operation. Generally, this should be done before attempting to program the instrument over the bus. The instrument will indicate that it is in the remote mode by illuminating its front panel REM indicator.

To place the counter in the remote mode, the controller must perform the following steps:

1. Set the REN line true.
2. Address the instrument to listen.

NOTE

Setting REN true without addressing will not cause the REM indicator to turn on. However, once REN is true, the REM light turns on the next time an address command is received.

EOI (End Or Identify) - The EOI command is used to positively identify the last byte in a multi-byte transfer sequence. This allows variable length data words to be transmitted easily.

IFC (Interface Clear) - The IFC command is sent to clear the bus and set the Model 2201 to a known state. **Table 4-4** summarizes the instrument's state after IFC or DCL. Although device configurations differ, the IFC command usually places instruments in the talk and listen idle states.

ATN (Attention) - The controller sends ATN while transmitting addresses or multiline commands. Device-dependent commands are sent with the ATN line high (false).

SRQ (Service Request) - The SRQ command is asserted by an external device when it requires service from the controller. If more than one device is present, a serial polling sequence must be used to determine which has requested service.

Universal Multiline Commands

Universal commands are multiline commands that require no addressing. All instrumentation equipped to implement the command will do so simultaneously when the command is transmitted over the bus. As with all multiline commands, the universal commands are sent over the data lines with ATN set low.

LLO (Local Lockout) - The LLO command is sent by the controller to remove the Model 2201 from the local operating mode. Once the unit receives the LLO command, all its front panel controls (except Power) will be inoperative.

NOTE

The REN bus line must be true before the instrument will respond to an LLO command.

To lock out the front panel controls of the instrument, the controller must perform the following steps:

1. Set ATN true.
2. Send the LLO command to the instrument.

DCL (Device Clear) - The DCL command may be used to clear the counter, setting it to a known state. Note that all devices on the bus equipped to respond to a DCL will do so simultaneously. When the instrument receives a DCL command, it will return to the default conditions listed in **Table 4-4**.

To send a DCL command the controller must perform the following steps:

1. Set ATN true.
2. Place the DCL command on the bus.

SPE (Serial Poll Enable) - The serial polling sequence is used to obtain the counter's status byte. Usually, the serial polling sequence is used to determine which of several devices has requested service over the SRQ line. However, the serial polling sequence may be used at any time to obtain the status byte from the instrument. For more information on status byte format, refer to paragraph on page 4-27. The serial polling sequence is conducted as follows:

1. The controller sets the ATN line true.
2. The SPE (Serial Poll Enable) command is placed on the bus by the controller.

3. The instrument is addressed to talk.
4. The controller sets ATN false.
5. The instrument then places its status byte on the bus to be read by the controller.
6. The controller then sets the ATN line low and places SPD (Serial Poll Disable) on the bus to end the serial polling sequence. Steps 3 through 5 may be repeated for other instruments on the bus by using the correct talk address for each instrument. ATN must be true when the talk address is transmitted and false when the status byte is read.

SPD (Serial Poll Disable) - The SPD command is sent by the controller to remove all instrumentation on the bus from the serial poll mode.

Table 4-4 Default Conditions. (Status After SDC or DCL)

Mode	Command	Status
Function	F0	Frequency A
Coupling	AC0	DC coupled on channel A
Attenuator	AA0	x1 attenuator on channel A
Filter	AF0	Filter off on channel A
Slope	AS0	Positive slope on channel A
Impedance	AI0	1 M Ω on channel A
Coupling	BC0	DC coupled on channel B
Attenuator	BA0	x1 attenuator on channel B
Filter	BF0	Filter off on channel B
Slope	BS0	Positive slope on channel B
Impedance	BI0	1 M Ω on channel B
Auto Trigger	L0	Manual trigger disabled
Delay	I0	Delay disabled
V Peak Rate	V0	Fast measurement rate
Totalize Mode	M0	Totalize infinitely
Displayed Digits	N9	Set maximum displayed digits to 9
Offset	O0	Set analog output offset to 0 V
Resolution	P0	Set analog output resolution to LSD
Rate	S1	Normal 3 readings per second
SRQ mask	Q0	SRQ disabled
Terminator	Z0	CR LF with EOI
Display mode	D0	Display the measurement
Data format	X0	Prefix on, no leading zeros
Trigger level	AL0	0 V on channel A
Trigger level	BL0	0 V on channel B
Gate time	G1	1 second gate time
Delay time	W1	1 second delay time

Addressed Commands

Addressed commands are multiline commands that must be preceded by a listen command derived from the device's primary address before the instrument will respond. Only the addressed device will respond to each of these following commands:

SDC (Selective Device Clear) - The SDC command performs essentially the same function as the DCL command except that only the addressed device will respond. This command is useful for clearing only a selected instrument instead of all devices simultaneously. The instrument returns to the default conditions listed in **Table 4-4** when responding to an SDC command.

To transmit the SDC command, the controller must perform the following steps:

1. Set ATN true.
2. Address the counter to listen.
3. Place the SDC command on the data bus.

GTL (Go To Local) - The GTL command is used to remove the instrument from the remote mode of operation. Also, front panel control operation will usually be restored if the LLO command was previously sent. To send the GTL command, the controller must perform the following sequence:

1. Set ATN true.
2. Address the counter to listen.
3. Place the GTL command on the bus.

NOTE

The GTL command does not remove the local lockout state. With the local lockout condition previously set, the GTL command will enable front panel control operation until the next time a listener address command is received. This places the instrument in the local lockout state again.

GET (Group Execute Trigger) - The GET command is used to trigger or arm devices to perform a specific measurement that depends on device configuration. Although GET is considered to be an addressed command, many devices respond to GET without being addressed. Using the GET command is only one of several methods that can be used to initiate a measurement cycle. More detailed information on triggering can be found in Chapter 3.

To send GET command over the bus, the controller must perform the following sequence:

1. Set ATN true.
2. Address the instrument to listen.
3. Place the GET command on the data bus.

GET can also be sent without addressing by omitting step 2.

Unaddress Commands

The two unaddress commands are used by the controller to simultaneously remove all talkers and listeners from the bus. ATN is low when these multiline commands are asserted.

UNL (Unlisten) - All listeners are removed from the bus at once when the UNL commands is placed on the bus.

UNT (Untalk) - The controller sends the UNT command to clear the bus of any talkers.

Device Dependent Commands

The meaning of the device-dependent commands is determined by instrument configuration. Generally, these commands are sent as one or more ASCII characters that tell the device to perform a specific function. For example, F0 is sent to the instrument to place it in the Frequency A mode. The IEEE-488.1 bus treats device-dependent commands as data in that ATN is high (false) when the commands are transmitted.

Device-Dependent Command Programming

IEEE-488 device-dependent commands are sent to the instrument to control various operating conditions such as, display modify, operating mode, output and parameter insertion. Each command is made up of an ASCII alpha character, followed by one or more numbers designating specific parameters. For example, the output waveform is programmed by sending an ASCII "U" followed by a number representing the output. The IEEE bus treats device-dependent commands as data in that ATN is high when the commands are transmitted.

A number of commands may be grouped together in one string. The instrument ignores all non-printable ASCII characters (00 HEX through 20 HEX) except the "CR" (carriage return). A command string is terminated by an ASCII "CR" (carriage return) character (0D HEX), which tells the instrument to execute the command string, recognized as end of command string.

If an illegal command or command parameter is present within a command string, the instrument will:

1. Ignore the entire string.
2. Display appropriate front panel error message.
3. Set certain bits in its status byte.
4. Generate an SRQ if programmed to do so.

NOTE

Before performing a programming example, it is recommended that the instrument be set to its default values by sending an SDC over the bus.

In order to send a device-dependent command, the controller must perform the following sequence:

1. Set ATN true.
2. Address the counter to listen.
3. Set ATN false.
4. Send the command string over the data bus one byte at a time.

NOTE

REN must be true when attempting to program the instrument.

Commands that effect the instrument are listed in **Table 4-5**.

Table 4-5 Device-Dependent Command Summary

Mode	Command	Description
Function	F0	Frequency on channel A
	F1	Frequency on channel B
	F2	Frequency on channel C
	F3	Period on channel A
	F4	Pulse on channel A
	F5	Time interval A to B
	F6	Totalize on B
	F7	Ratio A/B
	F8	Phase A to B
	F9	Peak Voltage on A
	F10	Period averaged on channel A
	F11	Pulse averaged on channel A
F12	Time interval A to B averaged	
Coupling	AC0	DC coupled on channel A
	AC1	AC coupled on channel A
	BC0	DC coupled on channel B
	BC1	AC coupled on channel B
Attenuator	AA0	x1 attenuator on channel A
	AA1	x10 attenuator on channel A
	BA0	x1 attenuator on channel B
	BA1	x10 attenuator on channel B
Filter	AF0	Filter off on channel A
	AF1	Filter on on channel A
	BF0	Filter off on channel B
	BF1	Filter on on channel B
Slope	AS0	Positive slope on channel A
	AS1	Negative slope on channel A
	BS0	Positive slope on channel B
	BS1	Negative slope on channel B

Table 4-5 Device-Dependent Command Summary (continued)

Mode	Command	Description
Impedance	A10 A11 B10 B11	1 M Ω on channel A
Trigger Level	ALn BLn	Set trigger level for channel A Set trigger level for channel B n = \pm d.dde \pm d d = integer from 0 to 9
Auto Level	L0 L1	Auto trigger level disabled Auto trigger level enabled
Gate Time	Gn GU	Set the gate time in seconds n = \pm d.dde \pm d d = integer from 0 to 9 Set gate time to user gate
Delay Time	Wn WU	Set the delay time in seconds n = \pm d.dde \pm d d = integer from 0 to 9 Set delay time to user delay
Delay	I0 I1	Delay disabled Delay enabled
V peak – peak Measurement Rate	V0 V1	Fast rate Slow rate
Totalize Modes	M0 M1 M2	Totalize infinitely on B Totalize on B by A Totalize on B by AA
Display Digits	Nn	Set the number of displayed digits n = 3 to 9

Table 4-5 Device-Dependent Command Summary (continued)

Mode	Command	Description
Analog Output Offset	On	Offset Set the analog output offset from n = 0 to 10. (0 corresponds to 0Vdc offset; 5 centers needle)
Resolution	Pn	Set the selected resolution for the analog output from n = 0 to 6 (0 will output the three least significant digits. 6 will output the three most significant digits)
Setups Store	STn	Store front panel setup in memory location - n
Recall	REn	Recall front panel set-up from memory location - n
Trigger	T	One-shot in S0 mode
Rate	S0	One-shot on T or GET
	S1	Normal -3 readings per second
	S2	Fast - 25 readings per second
SRQ Mask	Q0	SRQ disabled
	Q1	SRQ on ready
	Q2	SRQ on reading done
	Q4	SRQ on error
Terminator	Z0	CR LF with EOI
	Z1	CR LF without EOI
	Z2	LF CR with EOI
	Z3	LF CR without EOI
	Z4	CR with EOI
	Z5	CR without EOI
	Z6	LF with EOI
	Z7	LF without EOI
	Z8	No Terminator with EOI
	Z9	No Terminator without EOI

Table 4-5 Device-Dependent Command Summary (continued)

Mode	Command	Description
Display Mode	D0	Display the Measurement
	D1	Display the Gate Time
	D2	Display the Delay Time
	D3	Display the Trigger Level A
	D4	Display the Trigger Level B
	D5	Display the number of digits (Nn)
	D6	Display Analog Output resolution
	D7	Display Analog Output offset
Prefix	X0	Reading with prefix, no leading zero
	X1	Reading no prefix, no leading zero
	X2	Reading prefix, with leading zero
	X3	Reading no prefix, with leading zero
Readback	R0	Send measurement data string
	R1	Send Gate Time data string
	R2	Send Delay Time data string
	R3	Send Trigger Level A data string
	R4	Send Trigger Level B data string
	R5	Send Input conditioning status
	R6	Send Operating Mode Status
	R7	Send Error Status

Function (F)

The function command selects the type of measurement made by the instrument. The 10 parameters associated with the function command set the instrument to measure one of these functions. The function may be programmed by sending one of the following commands:

- F0 = Frequency A
- F1 = Frequency B
- F2 = Frequency C
- F3 = Period A
- F4 = Pulse A
- F5 = Time Interval A to B
- F6 = Totalize B
- F7 = Ratio A/B
- F8 = Phase A to B

F9 = Peak Voltage on A
F10 = Period Averaged A
F11 = Pulse Averaged A
F12 = Time Interval A to B Averaged

Coupling (AC,BC)

The coupling command gives the user control over the input coupling of the channel A and B inputs for the counter. The coupling may be programmed by sending one of the following commands:

AC0 = DC coupling channel A
AC1 = AC coupling channel A
BC0 = DC coupling channel B
BC1 = AC coupling channel B

**Channels A, B
Attenuator (AA,
BA)**

The attenuator command gives the user control over the input attenuation of the channel A and B inputs for the instrument. The attenuator may be programmed by sending one of the following commands:

AA0 = x1 attenuator channel A
AA1 = x10 attenuator channel A
BA0 = x1 attenuator channel B
BA1 = x10 attenuator channel B

**Channels A, B
Filter (AF, BF)**

The filter command gives the user control over the input filter of the channel A and B inputs for the instrument. The filter may be programmed by sending one of the following commands:

AF0 = filter on channel A
AF1 = filter off channel A
BF0 = filter on channel B
BF1 = filter off channel B

Channels A, B Slope (AS, BS)

The slope selection command gives the user control over the input slope mode of the channel A and B inputs for the instrument. The slope may be programmed by sending one of the following commands:

AS0 = Positive slope channel A

AS1 = Negative slope channel A

BS0 = Positive slope channel B

BS1 = Negative slope channel B

Channels A, B Impedance (AI, BI)

The impedance selection command gives the user control over the input impedance mode of the channel A and B inputs for the counter. The impedance may be programmed by sending one of the following commands:

A10 = 1 M Ω Impedance channel A

A11 = 50 Ω impedance channel A

B10 = 1 M Ω impedance channel B

B11 = 50 Ω impedance channel B

Channels A, B Trigger Level (AL, BL)

The trigger level selection command gives the user control over the input threshold point on the signal applied to the channels A and B inputs of the instrument. The trigger level may be programmed by sending one of the following commands:

ALn = Trigger level channel A

BLn = Trigger level channel B

where n is the trigger level in volts in engineering format, (e.g. <sign>D.DD<sign>D). The sign and the exponent are optional. The trigger level may range from -5.00 to +5.00 V in 10 mV steps or from -50.0 to +50.0 V in 100 mV steps. Selecting a trigger level in the range of ± 5.00 V will automatically set up the x1 attenuator. Selecting a trigger level in the range of ± 50.0 V will change the attenuator setting to x10 attenuator mode.

After DCL or SDC, the instrument defaults to AL0 and BL0 (trigger levels set at 0.00 V)

**Channels A, B
Auto trigger level
(L)**

The auto trigger level command gives the user control over the auto trigger level mode for channels A and B. The auto trigger level mode may be programmed by sending one of the following commands:

L0 = Auto trigger level disabled

L1 = Auto trigger level enabled

Gate Time (G, GU)

The gate time command controls the time that the gate remains open. The gate time may be programmed by sending a command using the following formats:

Gn = Internal gate time

GU = External user gate time

where n is the gate time in seconds in engineering format. e.g. (De<sign>D). The sign and the exponent are optional. The allowable values for gate time are listed in **Table 3-4**. The gate time may also be programmed to the external user gate time by sending the GU command over the bus.

After DCL or SDC, the instrument restarts with a gate time of one second (G1).

**Delay Time (W,
WU)**

The delay time command controls the amount of delay in closing the gate after the gate was open. The delay time may be programmed by sending a command using the following formats:

Wn = Internal delay time

WU = External user delay time

where n is the delay time in seconds in engineering format, (e.g. De<sign>D). The sign and the exponent are optional. The allowable values for delay time are listed in **Table 3-4**. The delay time may also be programmed to the external user delay time by sending the GU command over the bus.

After DCL or SDC, the instrument restarts with a delay time of one second (W1).

Peak Measurement Rate (V)

The V peak measurement rate command controls the rate of which the instrument performs the V peak measurements. The fast rate is normally used where the frequency to be measured is above 100 Hz. The slow rate is used for measurements below 100 Hz. The V peak measurement rate may be programmed by sending a command that has the following format:

V0 = Fast measurement rate
V1 = Slow measurement rate

Totalize Modes (M)

There are three totalize modes available with the instrument: Totalize infinitely, totalize by A and totalize by AA. The totalize mode command gives the user control over the selection of one of these totalize modes. The totalize mode may be programmed by sending a command using the following format:

M0 = Totalize infinitely on B
M1 = Totalize on B by A
M2 = Totalize on B by AA

Displayed Digits (N)

The displayed number of digits function sets the maximum number of digits that the counter displays. To program the number of digits send the following command:

Nn

where n may have any value from 3 to 9. Upon DCL or SDC, the instrument will be set to N9.

Analog Output Resolution (P)

The analog output resolution commands give the user control over the resolution range of the analog output string. To program the analog output resolution, send the following command:

P0 = 3 least significant digits.
Pn = any three adjacent digits

where n indicates the location of the right most digit. P6 = 3 most significant digits. n may range from 0 to 6. Upon DCL or SDC, the instrument will be set to P0.

Analog Output Offset (O)

The analog output offset command gives the user control over the offset, which will be applied to the output readout at the analog output rear panel connector. To program the analog output offset, send the following command:

On

where n may range from 0 to 9V. Upon DCL or SDC, the instrument is set to 0V. This command is valid if Option 08 is installed in the instrument.

Setup (ST, RE)

The setup commands select the memory location where the actual set-up is to be stored (ST) or from where recalled (RE). To store or recall a set-up use one of the following commands:

STn

REn

where n may range from 0 to 9. n is the memory address the set-up is to be stored or from where the setup is to be recalled. DCL or SDC has no effect on the stored setups.

Triggering (T)

The "T" and GET commands are used to trigger a measurement over the IEEE bus. Triggering arms a measurement cycle. In continuous mode, the counter is always armed and ready to take measurements. In hold mode (S0), a trigger stimulus is required to arm measurement cycles. To arm the instrument for a new measurement cycle use the following commands:

T = addressable trigger

GET = group execute trigger

Rate (S)

The rate command gives the user control over the measurement rate of the instrument. To change the measurement rate use the following commands:

S0 = Hold, One shot on T or GET or external arming input

S1 = Normal, Approximately 3 reading per second

S2 = Fast, Approximately 25 reading per second.

Note that S2 rate is not available through front panel programming.

Display Modes (D) The display command controls display readout. The eight parameters that are associated with this command set the instrument to display: measurements, gate time, delay time, trigger level A, trigger level B, number of selected digits, analog output resolution and analog output offset. The display readout may be programmed using the following commands:

- D0 = Display the normal measurement
- D1 = Display the gate time
- D2 = Display the delay time
- D3 = Display the A trigger level
- D4 = Display the B trigger level
- D5 = Display the number of digits
- D6 = Display the analog output resolution
- D7 = Display the analog output offset

SRQ Mode (Q) and Serial Poll Status Byte Format The SRQ command controls which of a number of conditions will cause the instrument to request service from the controller, with the SRQ line command. Once the SRQ is generated, the counter's status byte, using serial polling, can be checked to determine if it requested service. Other bits in the status byte could also be set depending on certain data or error conditions. The instrument can be programmed to generate SRQ under one of the following conditions.

1. If the instrument is ready to receive device-dependent commands.
2. If a reading has been completed.
3. If an error condition has occurred.

SRQ Mask: In order to facilitate SRQ programming, the instrument uses an internal mask to generate the SRQ. When a particular mask bit is set, the instrument sends an SRQ when those conditions occur. Bits within the mask can be controlled by sending the ASCII letter "Q", followed by a decimal number to set the appropriate bits. **Table 4-6** lists the commands to set the various mask bits, while **Table 4-7** lists all legal SRQ Mask commands.

Table 4-6 SRQ Mask Commands

Command	Sets Bit Number	Condition to Generate SRQ
Q1	B0 (LSB)	Ready
Q2	B1	Reading Done
Q4	B2	Error

NOTE

There are 8 legal SRQ mask commands that are available with the counter/timer. Table 4-7 lists all combinations.

Table 4-7 SRQ Mask Legal Commands

Command	B2	B1	B0 (LSB)
	Error	Reading Done	Ready
Q0	No	No	No
Q1	No	No	Yes
Q2	No	Yes	No
Q3	No	Yes	Yes
Q4	Yes	No	No
Q5	Yes	No	Yes
Q6	Yes	Yes	No
Q7	Yes	Yes	Yes

Status Byte Format: The status byte contains information pertaining to data and error conditions within the instrument. Table 4-4 lists the meaning of the various bits. The status byte is obtained by using SPE or SPD polling sequence

Table 4-8 Status Byte Interpretation

Bit Number	B7	B6	B5	B4	B3	B2	B1	B0 (LSB)
Interpretation	0	RQS	0	0	0	Error	Reading Done	Ready

The various bits in the status byte are described below:

1. **Ready:** Set after power-up. This bit is cleared when the instrument receives a command and set again when the instrument has completed decoding the command and is ready to accept the next command.
2. **Reading done:** Set after completion of a measurement cycle. The reading done bit is cleared after the counter was addressed to talk in R0 mode.
3. **Error:** Set if an illegal command has been received or one of gate, gate time or trigger level errors have occurred in the last measurement cycle. Reading the error status (R7) clears this bit.
4. **RQS:** The instrument sets this bit if one or more conditions for service request occurs, and the SRQ mask, for at least one of these service request conditions is enabled. Reading the status byte using the SPE, SPD polling sequence clears this bit.

NOTES

1. Once the counter has generated an SRQ, its status byte should be read to clear the SRQ line, otherwise the instrument continuously asserts the SRQ line.

2. The instrument can be programmed to generate an SRQ for more than one condition simultaneously. For example, to set SRQ mask bits for an SRQ if an error occurs and when the instrument is ready for the next string, the following command would be sent: Q5. All possible mask combinations are listed in Table 4-7.

3. If the instrument is programmed to generate an SRQ when reading is done, it will generate the SRQ only once after completing the reading. Reading the status byte may clear the SRQ. The reading done bit in the status byte may then be cleared by requesting a normal reading from the instrument (R0).

Reading From the Instrument

The Reading sequence is used to obtain various information strings such as measurements, gate time, delay time or trigger levels. Each information string is made up of ASCII alpha and alphanumeric characters.

The reading sequence is conducted as follows:

1. The controller sets the ATN line true.
2. The counter is addressed to talk.
3. The controller sets ATN false.
4. The instrument sends the information string over the bus one byte at a time.
5. The controller recognizes that the string is terminated.
6. The controller sets the ATN line true.
7. The UNT (untalk) command is placed on the bus by the controller.

NOTE

Most controllers use the CR (Carriage Return) or LF (Line Feed) character to terminate their input sequences, but other techniques may be used as well to recognize the end of input sequence (for example the EOI line is low on the bus during the transfer of the last byte).

Data Control Commands (R)

The Data Control commands allow access to information concerning present operating conditions of the instrument. When the data control command is given, the instrument transmits a data string instead of its normal reading. The next time it is addressed to talk the counter will respond with its normal measurement data string (R0).

The Data Control commands include:

- R0 = Send normal measuring data string
- R1 = Send Gate Time data status string
- R2 = Send Delay Time data status string
- R3 = Send Trigger Level A data status string
- R4 = Send Trigger Level B data status string
- R5 = Send Input conditioning status string
- R6 = Send Operating Mode Status string
- R7 = Send Error Status string

Table 4-9 shows the general data string format for each of the above commands (decimal point floats). **Table 4-10** shows the interpretation for the input conditioning status, operating mode status and error status strings (R5, R6 and R7).

NOTES

1. Data strings have fixed length of 14 ASCII characters for the R0, R5 and R6 commands without the prefix and terminator. For all other data strings (R1 through R4 and R7), the length of the data string is 5 ASCII characters without the prefix and terminator. If the data string is sent with a prefix, four additional ASCII characters are included. If the data string is sent with one or two terminators, the length of the data string increases by one or two characters respectively.

2. All normal measurement data strings (R0), besides the status strings (R1 through R7), are sent only once after a successful measurement cycle. This may halt the controller for the duration of the gate or delay time. It is therefore recommended that the status byte be continuously monitored and normal reading taken only after the READING DONE bit is set true.

3. All status strings, besides normal data strings, are sent only once for each query. Once the data string is read, the instrument sends normal data strings (R0) the next times it is addressed to talk.

Table 4-9 Data String Formats

Command	Data String Format	Description
R0	<FRQA>+1.23456789E+0 (TERM) <FRQB>+1.23456789E+0 (TERM) <FRQC>+1.23456789E+0 (TERM) <PERS>+1.23456789E+0 (TERM) <PLSS>+1.23456789E+0 (TERM) <TABS>+1.23456789E+0 (TERM) <TOTB>+1.23456789E+0 (TERM) <APRB>+1.23456789E+0 (TERM) <PHAS>+1.23456789E+0 (TERM) <VPKA>-0.00 -0.00 (TERM) <PERV>+1.23456789E+0 (TERM) <PLSV>+1.23456789E+0 (TERM) <TABV>+1.23456789E+0 (TERM)	for FRQ A measurements for FRQ B measurements for FRQ C measurements for PER A measurements for PLS A measurements for T.I A->B measurements for TOT B measurements for RATIO A/B measurements for Phase A to B measurements for V Peak A measurements for PER AVG A measurements for PLS AVG measurements for T.I A to B AVG measurements
R1	<GATE>+1E+0 (TERM)	for Gate Time
R2	<DLAY>+1E+0 (TERM)	for Delay Time
R3	<TRGA>+0.00 (TERM)	for Trig Level A
R4	<TRGB>+0.00 (TERM)	for Trig Level B
R5	<STAT>00000000000000 (TERM)	Input conditioning status
R6	<2201>00000900100000 (TERM)	Machine status
R7	<EROR>00000 (TERM)	Error status

CR LF is normal terminator. The terminator may be. Prefixes are listed in **Table 4-9**.

Table 4-10 Status Word Interpretation

R5	F	AC	AA	AF	AS	AI	BC	BA	BF	BS	BI	L	I	(term)
After SDC	00	0	0	0	0	0	0	0	0	0	0	0	0	(CR LF)

R6	<2201>	Opt1	Opt2	Opt3	V	M	N	O	P	S	Q	Z	D	X	0	(term)
After SDC	<2201>	n	n	n	0	0	9	0	0	1	0	0	0	0	0	(CR LF)

R7	<EROR>	ILI	ILP	GATEERR	TLERR	0	(term)
After SDC	<EROR>	0	0	0	0	0	(CR LF)

NOTES

1. The Error Status string will be returned only once after each time the command is sent. Once status is read, the instrument will send its normal string the next time the instrument is addressed to talk and reading done bit is set true.
 2. To ensure that the correct status is received, the status string should be read immediately after sending the query.
 3. The status string should not be confused with the status byte. The status string contains a string of bytes pertaining to the various operating modes of the instrument. The status byte is a single byte that is read with the SPE, SPD command sequence and contains information on RSQ status.
 4. Reading R7 clears the error status string. Reading this status also clears the reading done and the error bits in the status byte.
-

Terminator (Z)

Sending an appropriate command over the bus can change string terminator. The default value is the commonly used carriage return, line feed (CR LF) sequence (mode Z0). The terminator sequence assumes this default value after receiving a DCL or SDC.

The EOI line on the bus is usually set low by the device during the last byte of its data transfer sequence. In this way, the last byte is properly identified, allowing variable length data words to be transmitted. The counter normally responds with an EOI during the last byte of its data string or status word. The terminator and the EOI response from the instrument can be programmed using the following commands:

- Z0 = CR, LF with EOI
- Z1 = CR, LF without EOI
- Z2 = LF, CR with EOI
- Z3 = LF, CR without EOI
- Z4 = CR with EOI
- Z5 = CR without EOI
- Z6 = LF with EOI
- Z7 = LF without EOI
- Z8 = No terminator with EOI
- Z9 = No terminator without EOI

NOTES

- 1. Most controllers use the CR or LF character to terminate their input sequence. Using the NO TERMINATOR mode (Z8 or Z9) may cause the controller to hang up unless special programming is used.**
 - 2. Some controllers may require that EOI be present at the end of transmitting.**
-

Prefix (X)

The prefix from the data string may be suppressed using this command. When the prefix is suppressed the output data string is four bytes shorter. The X command is also used to replace leading space character (ASCII 20 HEX) in the data string with character 0 (ASCII 30 HEX). For some controllers, an attempt to read a number instead of a string, may result in a reading error because of its inability to read spaces before the first significant digit. To eliminate this problem the instrument should be programmed to send the data string with leading zeros. X command parameters include:

- X0 = Send data string with prefix, without leading zero
- X1 = Send data string without prefix, without leading zero
- X2 = Send data string with prefix, with leading zero
- X3 = Send data string without prefix, with leading zero

Front Panel Error Messages

The process of programming the counter/timer involves the proper use of syntax. Syntax is defined as the orderly or systematic arrangement of programming commands or languages. The instrument must receive valid commands with proper syntax or it will:

1. Ignore the entire command string in which the invalid command appears.
2. Set appropriate bits in the status byte and error word.
3. Generate an SRQ if programmed to do so.
4. Display an appropriate front panel message.

ILL INS (Illegal Instruction) Error

An ILL INS error results when the instrument receives an invalid command such as A0. This command is invalid because no such letter exists in the instruments programming language.

ILL PAR (Illegal Parameter) Error

An ILL PAR error occurs when the numeric parameter associated with a legal command letter is invalid. For example, the command D10 has an invalid option because the counter does not have a display mode that is associated with this number.

This page was left intentionally blank.

MAINTENANCE AND PERFORMANCE CHECKS

Introduction

This section provides performance tests for the counter/timer. A fuse replacement procedure, and line voltage selection procedure is also included. It is recommended that these procedures be carried out at a minimum interval of 1 year.



WARNING

The procedures described in this section are for use only by qualified service personnel. Do not perform these procedures unless qualified to do so. Many of the steps covered in this section may expose the individual to potentially lethal voltages that could result in personal injury or death if normal safety precautions are not observed.

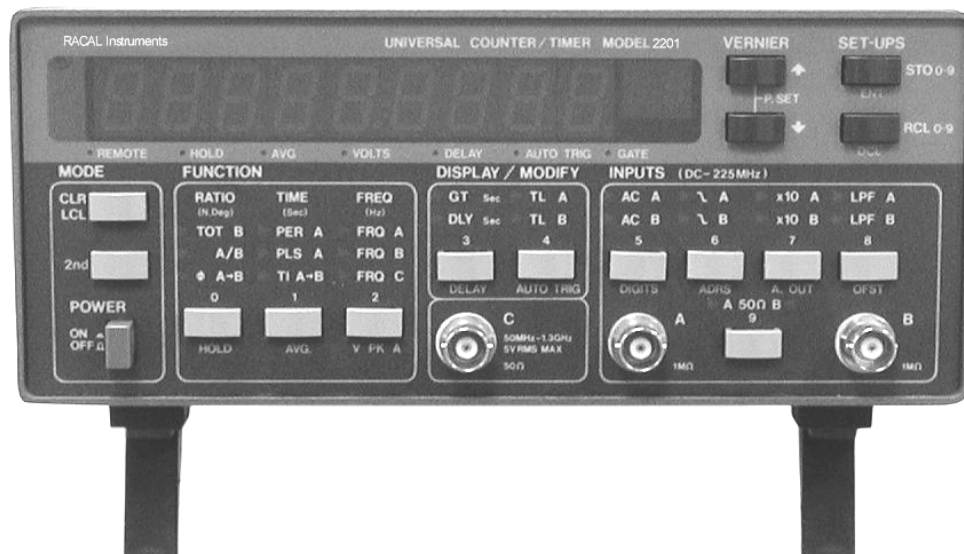

Figure 5-1 2201 Counter/Timer

Line Voltage Selection



The Model 2201 may be operated from either 115V or 230V nominal 50-60Hz power sources. A special transformer may be installed for 100V and 200V ranges. The instrument was shipped from the factory set for an operating voltage of 230V. To change the line voltage, proceed as follows:

WARNING

Disconnect the Model 2201 from the power cord and all other sources before changing the line voltage setting.

1. Using a flat-blade screwdriver, place the line voltage selection switch in the desired position. The voltages are marked on the selection switch.
2. Install a power line fuse consistent with the operating voltage. See Fuse Replacement.



CAUTION

The correct fuse type must be used to maintain proper instrument protection.

Fuse Replacement



The Model 2201 has a line fuse to protect the instrument from excessive current. This fuse may be replaced by using the procedure described in the following :

WARNING

Disconnect the instrument from the power line and from other equipment before replacing the fuse.

1. Place the end of a flat-blade screwdriver into the slot in the LINE FUSE holder on the rear panel. Push in and rotate the fuse carrier one-quarter turn counterclockwise. Release the pressure on the holder and its internal spring will push the fuse and the carrier out of the holder.
2. Remove the fuse and replace it with the proper type using **Table 5-1** as a guide.



CAUTION

Do not use a fuse with a rating higher than specified or instrument damage may occur. If the instrument persistently blows fuses, a problem may exist within the instrument. If so, the problem must be rectified before continuing operation.

Table 5-1 Line Fuse Selection

Power	Line Voltage	Fuse Type
90 -125V	0.4A, 250V	5x20 mm Slow Blow
195-250V	0.2A, 250V	5x20 mm Slow Blow

Using an External 10MHz Reference Input

1. Remove the top and bottom covers of the instrument as described in the paragraph on "Disassembly Instructions".

WARNING

Disconnect the line cord and test leads from the instrument before removing the top cover.

2. LK1a/LK1b is used for selecting between internal and external references. Proper positioning of LK1a/LK1b is described in **Figure 5-2**.

Note that the rear panel BNC connector is used as an output when the internal reference is selected. When LK1a/LK1b is set to accept an external reference, the same rear panel connector is used as an input for the reference frequency.

3. External reference frequency may be selected from one of three standard frequencies: 1MHz, 5MHz or 10MHz.
4. Replace the bottom and top covers.
5. Turn on the power and observe the power up procedure.

Applying a wrong reference frequency to the rear panel connector and trying to measure frequency will cause the Model 2201 to display the following message:

no rEF

This reading indicates that the instrument can not lock to the external reference frequency. When such a reading occur, check the position of LK2 as described in the above.

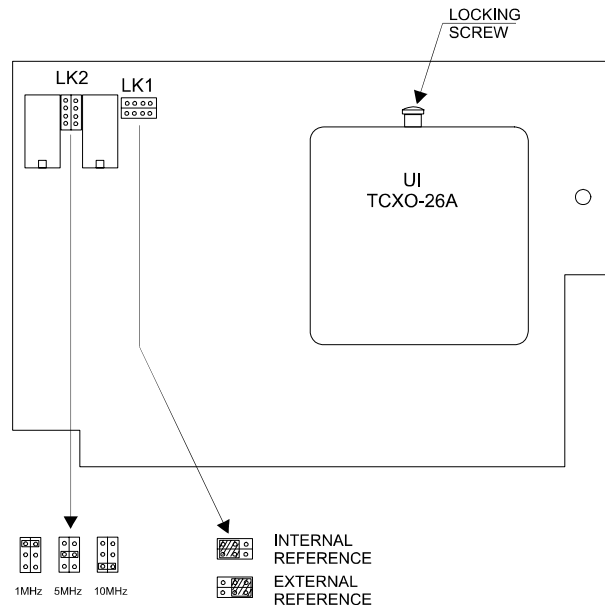

Figure 5-2 Reference Frequency and INT/EXT Clock Selection.

Analog Output Option (Option 08)

The analog output option expands the capability of the Model 2201 by providing, through a rear panel BNC connector, a high accuracy dc voltage. This DC voltage is directly proportional to any three selectable adjacent digits. This voltage may be later used to drive a chart recorder or XY plotter. If purchased with the Model 2201, the option will be factory installed. Option 08 can not be installed in the field; however the instrument may be sent to the factory for an upgrade. Consult your nearest service center when such an upgrade is required.

To check for Option 08 in your Model 2201, turn the power on and observe the power-up procedure. If no other option is installed the instrument will display the following:

2201-X1X

where the X's represent other options.

This reading indicates that option 08 is installed. For other indications during power-up sequence refer to Chapter 3, "The Analog Output".

Disassembly Instructions

If it is necessary to troubleshoot the instrument or replace a component, use the following disassembly procedure to remove the top and bottom covers:

1. Remove the four screws that secure each of the top and the bottom covers.
2. Grasp the top cover at the side and carefully lift it off the instrument. Similarly remove the bottom cover.
3. When replacing the covers, reverse the above procedure.

Special Handling of Static Sensitive Devices

MOS devices are designed to operate at a very high impedance level for low power consumption. As a result, any normal static charge that builds up on your person or clothing may be sufficient to destroy these devices if they are not handled properly. When handling such devices, use precautions that are below to avoid damaging them.



1. The MOS ICs should be transported and handled only in containers specially designed to prevent static build-up. Typically, these parts will be received in static-protected containers of plastic or foam. Keep these devices in their original containers until ready for installation.
2. Remove the devices from the protective containers only at a properly grounded work station. Also ground yourself with a suitable wrist strap.
3. Remove the devices only by the body; do not touch the pins.
4. Any printed circuit board into which the device is to be inserted must also be grounded to the bench or table.
5. Use only anti-static type solder sucker.
6. Use only grounded soldering irons.
7. Once the device is installed on the PC board, the device is normally adequately protected, and normal handling resume.

Cleaning

Model 2201 should be cleaned as often as operating condition require. Thoroughly clean the inside and the outside of the instrument. Remove dust from inaccessible areas with low pressure compressed air or vacuum cleaner. Use alcohol applied with a cleaning brush to remove accumulation of dirt or grease from connector contacts and component terminals.

Clean the exterior of the instrument and the front panel with a mild detergent mixed with water, applying the solution with a soft, lint-free cloth.

Repair and Replacement

Repair and replacement of electrical and mechanical parts must be accomplished with great care and caution. Printed circuit boards can become warped, cracked or burnt from excessive heat or mechanical stress. The following repair techniques are suggested to avoid accidental destruction or degradation of parts and assemblies.

Use an ordinary 60/40 solder and 35 to 40 watt pencil type soldering iron on the circuit board. The tip of the iron should be clean and properly tinned for best heat transfer to the solder joint. A higher wattage soldering iron may separate the circuit from the base material. Keep the soldering iron in contact with the PC board for a minimum time to avoid damage to the components or printed conductors.

To desolder components, always use Solder wick, size 3. Always replace a component with its exact duplicate as specified in the parts list.

Performance Checks

The following performance checks verify proper operation of the instrument, and should normally be used :

- a. As part of incoming inspection of instrument specifications;
- b. As part of troubleshooting procedure;
- c. After any repair or adjustment, before returning instrument to regular service.

Environmental Conditions

Tests should be performed under laboratory conditions having an ambient temperature of $25 \pm 5^{\circ}\text{C}$ and a relative humidity of less than 80%. If the instrument has been subjected to conditions outside these ranges, allow at least one additional hour for the instrument to stabilize before beginning the adjustment procedure.

Warm-Up Period

Most equipment is subject to at least a small amount of drift when it is first turned on. To ensure accuracy, turn on the power to the Model 2201 and allow it to warm-up for at least 30 minutes before beginning the performance tests procedure.

Recommended Test Equipment

Recommended test equipment for troubleshooting, calibration and performance checking is listed below. Test instruments may be used only if their specifications equal or exceed the required minimum characteristics.

- (1) Signal Generator, 10kHz to 1.3GHz, <100ppm
- (2) Pulse Generator, 0.5s to 20ns, <100ppm
- (3) Digital Multimeter, >0.05% Accuracy, 100mV-100V
- (4) 10MHz Frequency Standard, $10\text{MHz} \pm 10^{-12}$
- (5) 50Ω Tee, Banana to BNC Connector

Performance Checks Procedure

Channel A and B Sensitivity Checks

Equipment: Synthesized signal generator

Procedure:

1. Connect the test equipment as described in **Figure 5-3**.

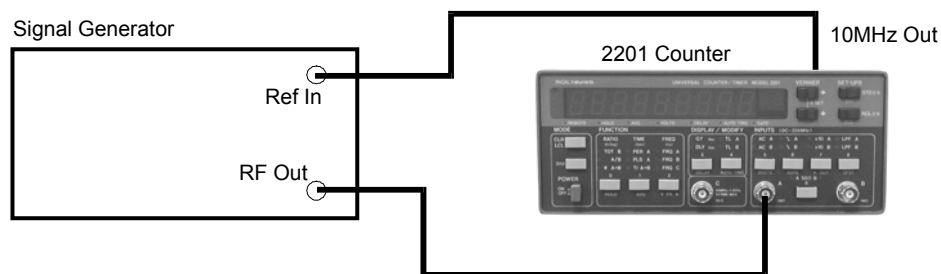

Figure 5-3 Channels A and B Sensitivity Test Set-up.

2. Press Model 2201 push-buttons in the following sequence: [2nd], [DCL] and then [50Ω].
3. Set Synthesizer frequency and amplitude as given in the following table and verify a stable counter readings as follows:

SYNTHESIZER FREQUENCY	SIGNAL LEVEL (rms)	REQUIRED COUNTER READING	ALLOWED ERROR
1MHz	25mV	1.00000000E+6	±2Hz
80MHz	25mV	80.000000E+6	±2Hz
100MHz	25mV	100.000000E+6	±2Hz
150MHz	50mV	150.000000E+6	±2Hz
225MHz	50mV	225.000000E+6	±2Hz

4. Change synthesizer frequency setting to 10MHz and signal level setting to 25mV rms.
5. Press the [LPF] push-button and observe that the counter does not process any more readings.

6. Again press the [LPF] and then the [x10] push-button and observe that the Model 2201 still does not process readings.
7. Change synthesizer amplitude level setting to 250mV rms.
8. Verify that counter reading is 10MHz \pm 2Hz.
9. Modify the connections in **Figure 5-3** above so that the synthesizer will now be connected to Channel B. Select [FREQ B].
10. Repeat the procedure above to verify Channel B sensitivity.

Channel C Sensitivity Check

Equipment: Synthesized signal generator

Procedure:

1. Connect the test equipment as described in **Figure 5-4**.

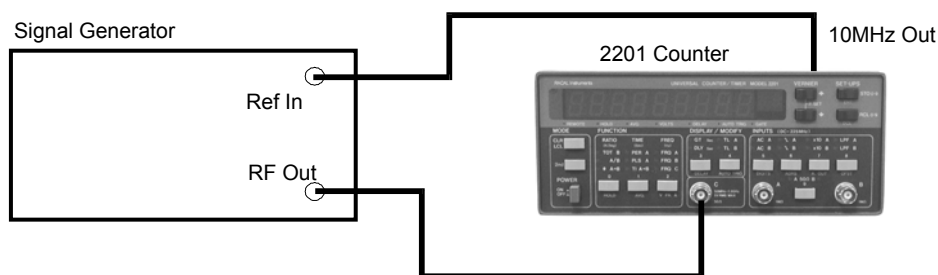

Figure 5-4 Channel C Sensitivity Test Set-up.

2. Press Model 2201 push-buttons in the following sequence: [2nd], [DCL] and then [FREQ C].
3. Set Synthesizer frequency and amplitude as given in the following table and verify a stable counter readings as follows:

SYNTHESIZER FREQUENCY	SIGNAL LEVEL (rms)	REQUIRED COUNTER READING	ALLOWED ERROR
100MHz	25mV	100.00000E+6	\pm 1 LSD
500MHz	25mV	500.00000E+6	\pm 1 LSD
1000MHz	25mV	1.0000000E+9	\pm 1 LSD
1300MHz	50mV	1.3000000E+9	\pm 1 LSD

Period A, Period A Averaged Operation Check

Equipment: Synthesized signal generator

Procedure:

1. Connect the test equipment as described in **Figure 5-5**.

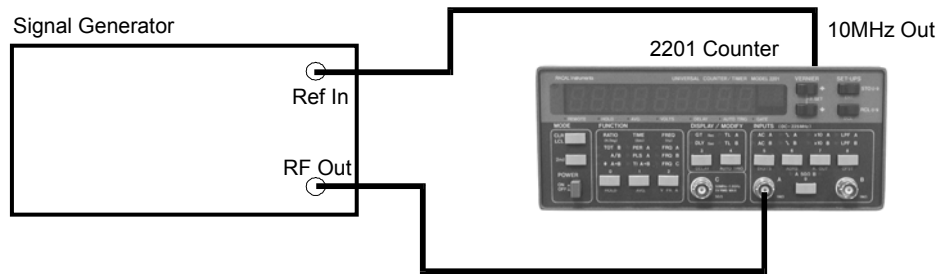

Figure 5-5 Period A and Period A Averaged Test Set-up.

2. Press Model 2201 push-buttons in the following sequence: “[2nd]”, [DCL], [PER A] and then [50Ω].
3. Set Synthesizer frequency to 1MHz and amplitude level to 50mV rms.
4. Verify a stable counter readings as follows:

1.00E-6 ±1 LSD

5. Press [2nd] and then [AVG] push-buttons.
6. Set Synthesizer frequency to 125MHz and amplitude level to 50mV rms.
7. Verify a stable counter readings as follows:

8.0000000E-9 ±1 LSD

Ratio A/B Operations Check

Equipment: Synthesized signal generator

Procedure:

1. Connect the test equipment as described in **Figure 5-6**.
2. Press Model 2201 push-buttons in the following sequence: [2nd], [DCL], [A/B], [AC B] and then [50Ω A&B].
3. Set Synthesizer frequency to 225MHz and amplitude level to 50mV rms.

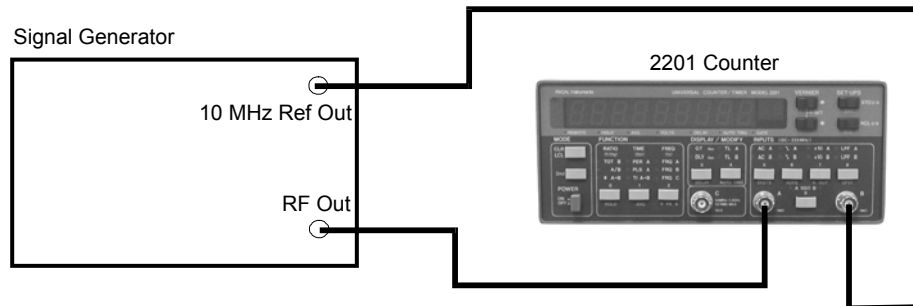

Figure 5-6 Ratio A/B Test Set-up.

4. Verify a stable counter readings as follows:

22.5000000 ±1 LSD

Pulse A, T.I A to B, Pules A Avg and T.I Avg Operation Check

Equipment: Pulse generator

Procedure:

1. Connect the test equipment as described in **Figure 5-7**. It is essential that both cables to channels A and B are exactly equal in length.

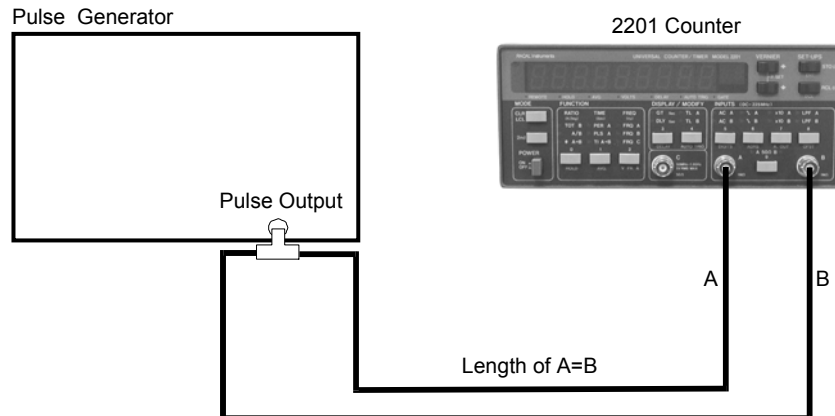

Figure 5-7 Pulse A, T.I A to B and Averaged Test Set-up.

2. Press Model 2201 push-buttons in the following sequence: [2nd], [DCL], [PLS A] and then [50Ω A&B].
3. Set Pulse generator parameters as follows:
 - Output Waveform - Pulse
 - Pulse Period - 8μs
 - Pulse Width - 2μs
 - Pulse Amplitude - 5Vp-p
 - Pulse DC Offset - 0V
4. Verify a stable counter readings as follows:
 - 2.00E-6 ±11 LSD
5. Press [2nd] and then [AVG] to select PULSE A AVG.
6. Verify a stable counter readings as follows:
 - 2.0000E-6 ±0.1100
7. Press [2nd] and then [AVG] to defeat the AVG function.
8. Select [TI A→B] and [↓ A] functions by pressing the appropriate push-buttons.

9. Verify a stable counter readings as follows:

6.00E-6 ±20 LSD

10. Select negative slope for Channel B.

11. Verify a stable counter readings as follows:

2.00E-6 ±11 LSD

12. Press [2nd] and then [AVG] to select TI A→B AVG.

13. Verify a stable counter readings as follows:

2.0000E-6 ±0.1100

Phase A to B Operation Check

Equipment: Pulse generator

Procedure:

1. Connect the test equipment as described in **Figure 5-8**. It is essential that both cables to channels A and B are exactly equal in length.
2. Press Model 2201 push-buttons in the following sequence: [2nd], [DCL], [ϕ A-B], [\downarrow A] and then [50 Ω A&B].

3. Set Pulse generator parameters as follows:

Output Waveform - Square wave

Frequency - 15kHz

Amplitude - 5Vp-p

Offset - 0V

Duty Cycle - 50%

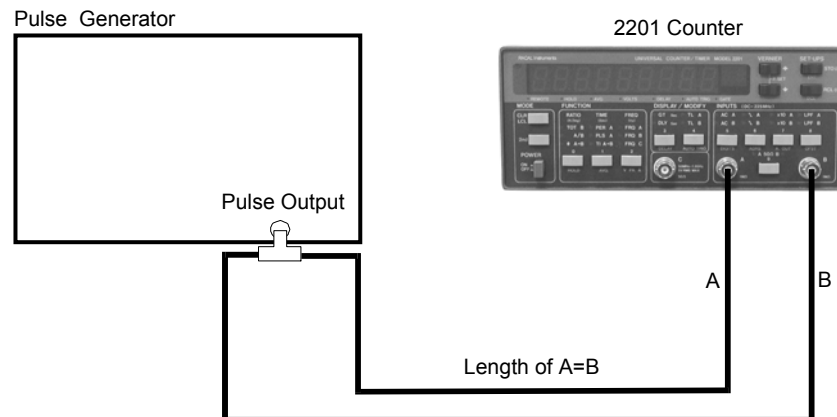

Figure 5-8 Phase A to B Test Set-up.

4. Verify a stable counter readings as follows:

180.00 \pm 2.00

Totalize B Operation Check

Equipment: Pulse generator

Procedure:

1. Connect the test equipment as described in **Figure 5-9**.

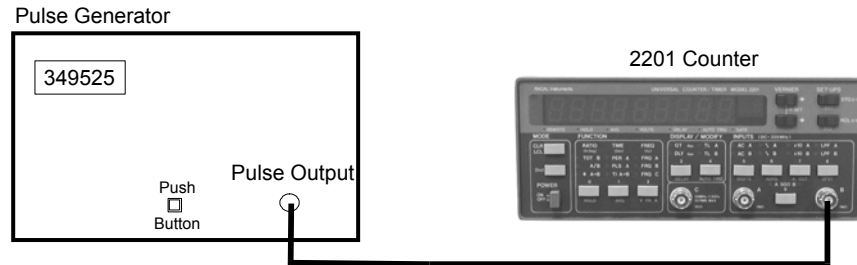

Figure 5-9 Totalize B Test Set-up.

2. Press Model 2201 push-buttons in the following sequence: [2nd], [DCL], [TOT B], [50Ω] and then [CLR].
3. Set Pulse generator parameters as follows:

Output Waveform	- Square wave		
Trigger Mode	- Burst	Trigger Source	- EXT.
Frequency	- 10MHz	Trigger Slope	- Positive
Amplitude	- 5Vp-p	Burst	- 349525
4. Press the pulse generator MANUAL trigger push-button. Verify a counter readings as follows:

349525

5. Again press the pulse generator MANUAL trigger push-button. Verify a counter readings as follows:

699050

Auto Trigger Level A and B Operation Check

Equipment: Pulse generator

Procedure:

1. Connect the test equipment as described in **Figure 5-10**.

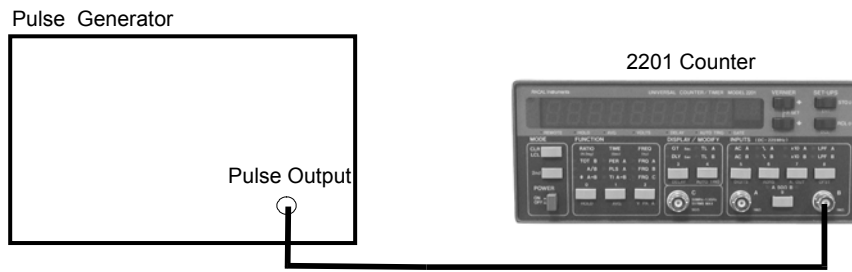

Figure 5-10 Auto Trigger A and B Test Set-up.

2. Press Model 2201 push-buttons in the following sequence: [2nd], [DCL], [50Ω A], [2nd], [AUTO TRIG] and then [TL A].
3. Set Pulse generator parameters as follows:
 - Output Waveform - Square wave
 - Frequency - 50kHz
 - Amplitude - 1.6Vp-p
 - Offset - 3.8V
 - Symmetry - 50%
4. Verify that trigger level A reading is as follows:

$$3.80V \pm 0.20V$$
5. Modify the connections in **Figure 5-10** above so that the pulse generator will now be connected to Channel B.
6. Press Model 2201 push-buttons in the following sequence: [2nd], [DCL], [FREQ B], [50Ω B], [2nd], [AUTO TRIG] and then [TL B].
7. Repeat the procedure above to verify Channel B auto trigger level operation.

Delay Operation Check

Equipment: Pulse generator

Procedure:

1. Connect the test equipment as described in **Figure 5-11**.

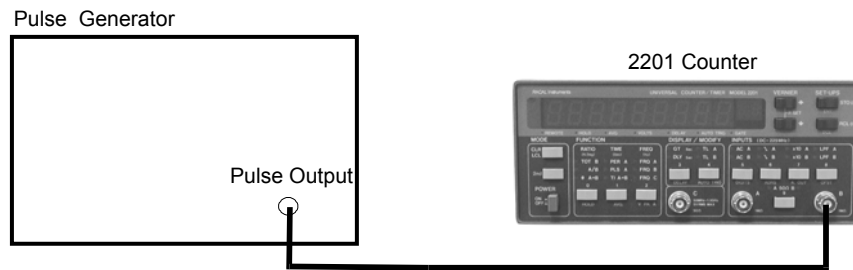

Figure 5-11 Delay Test Set-up.

2. Press Model 2201 push-buttons in the following sequence: [2nd], [DCL], [PER A], [50Ω], [2nd] and then [DELAY].
3. Set Pulse generator parameters as follows:
 - Output Waveform - Square wave
 - Frequency - 20MHz
 - Amplitude - 5Vp-p
 - Offset - 0V
 - Duty Cycle - 50%
4. Verify a stable counter reading as follows:

1s ±5ms

User Gate Operation Check

Equipment: Pulse generator

Procedure:

1. Connect the test equipment as described in **Figure 5-12**.

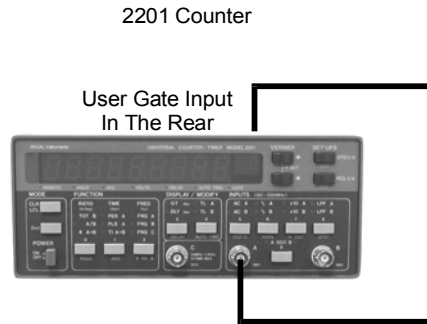

Figure 5-12 User Gate Test Set-up.

2. Press Model 2201 push-buttons in the following sequence: [2nd], [DCL], [50Ω] and then [AC A].
3. Select the USER GATE function on the counter. (Refer to Chapter 3).
4. Set Pulse generator frequency to 5MHz.
5. Verify a stable counter reading as follows:

10.000000E+6 ±1 LSD

Analog Output Operation Check

Equipment: DMM

Procedure:

1. Connect the test equipment as described in **Figure 5-13**.
2. Press Model 2201 push-buttons in the following sequence: [2nd], [DCL], [50Ω], [AC A], [2nd] and then [A OUT].
3. Use the VERNIER UP bush-button to select the following reading on the display: (Refer to Chapter 3).

10.0_____

4. Press [2nd] and then [OFST] push-buttons.

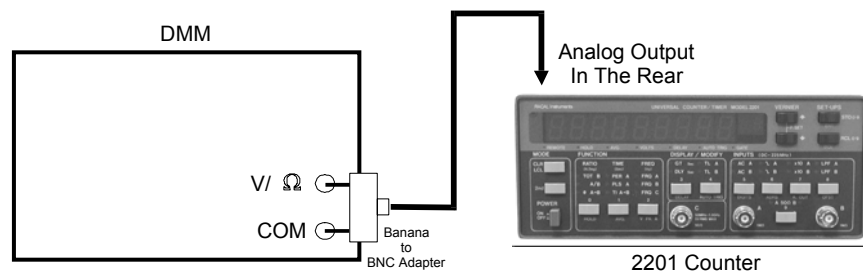

Figure 5-13 Analog Output Test Set-up.

5. Use the VERNIER UP bush-button to modify the offset to 800. (Refer to Chapter 3).
6. Verify a DMM reading as follows:

9.000V ±0.005V

Time Base Accuracy Check

Equipment: 10MHz standard

Procedure:

1. Connect the test equipment as described in **Figure 5-14**.

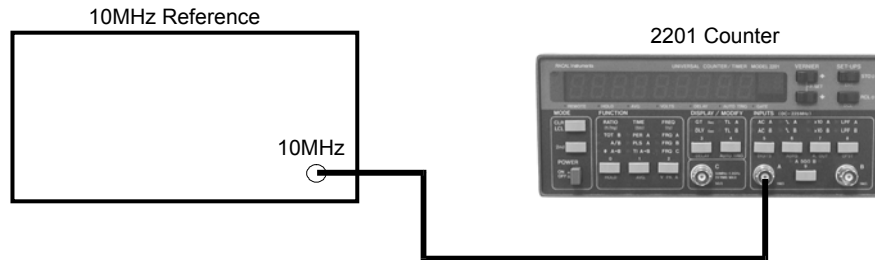

Figure 5-14 Time Base Accuracy Test Set-up.

2. Press Model 2201 push-buttons in the following sequence: [2nd], [DCL], [50Ω], [2nd] and then [AUTO TRIG].
3. Verify a stable counter reading as follows:

TCXO: 10.000000E+6 ±100 LSD

OCXO: 10.000000E+6 ±10 LSD

Rubidium: 10.000000E+6 (no error)

Chapter 6

ADJUSTMENTS

INTRODUCTION

This section contains information necessary to adjust the Model 2201, the TCXO and time base multiplier, the 1.3GHz channel C input (Option 41) and, the analog output (Option 08). These procedures are to be carried out after repair of the 2201 or the failure of a routine performance check.

WARNING

The procedures described in this section are for use only by qualified service personnel. Do not perform these procedures unless qualified to do so. Many of the steps covered in this section may expose the individual to potentially lethal voltages that could result in personal injury or death if normal safety precautions are not observed.

ADJUSTMENTS

Environmental Conditions

Adjustments should be performed under laboratory conditions having an ambient temperature of 25 ± 5 °C and a relative humidity of less than 70%. If the instrument has been subjected to conditions outside these ranges, allow at least one additional hour for the instrument to stabilize before beginning the adjustment procedure.

Warm-Up Period

Most equipment is subject to at least a small amount of drift when it is first turned on. To ensure long-term calibration accuracy, turn on the power to the Model 2201 and allow it to warm-up for at least 30 minutes before beginning the adjustment procedure.

Recommended Test Equipment

Recommended test equipment for calibration is listed below.

Test instruments may be used only if their specifications equal or exceed the required minimum characteristics.

- 1) Digital Multimeter, >0.05% Accuracy, 100mV to 100VDC, Ω Reading
- 2) Signal Generator, 1MHz to 1.3GHz, <100ppm
- 3) DC Volts Calibrator, 1V to 100V, 0.01%
- 4) 10MHz Frequency Standard, 10MHz $\pm 10^{-12}$

Adjustment Procedures

All adjustments are performed with the POWER switch ON. The top cover should be removed to allow access to test points and adjustments. Between adjustments, always leave top cover on the unit to keep internal temperature.

WARNING



Take special care to prevent contact with live circuits or power line area that could cause electrical shock resulting in serious injury or death. Use an isolated tool when making adjustments. Use plastic or nylon screw-driver when adjusting the time base trimmer as other material will cause confusion in this adjustment.

Refer to **Figure 6-1**, throughout the following adjustment procedures, for determining adjustment points. Follow the procedure in the sequence indicated because some of the adjustments are interrelated and dependent on the proceeding steps.

Verify that the Model 2201 is functioning according to the performance checks. Make sure that all results are within, or close to, the range of the required specifications, otherwise contact the Racal Instruments Customer Service department for repair information.

Perform the following adjustment procedure. If an adjustment can not be made to obtain a specific result, contact the Racal Instruments Customer Service department for repair information.

ADJUSTMENT PROCEDURE

POWER SUPPLY ADJUSTMENT



Equipment: DMM

Procedure:

1. Set DMM to DCV measurements. Connect the DMM between ground and the +5 V test point.
2. Adjust R190 for a DMM reading of +5.000 V \pm 10mV DC.

TRIGGER LEVEL A ADJUSTMENT



Equipment: DMM, DC voltage calibrator

Procedure:

1. Set DMM to DCV measurements.
2. Set **[TL A]** to 0.00 V.
3. Measure and record the voltage at U12 pin 8. Record this voltage with a resolution of \pm 0.001 V.
4. Set **[TL A]** to 5.00 V.
5. Set DC calibrator output setting to +5.000 V.
6. Using a banana to BNC adapter, connect the calibrator output to the Channel A input connector.
7. Re-connect the DMM probes to U12 pin 8 and adjust R80 to obtain the same voltage level as recorded in step 3.

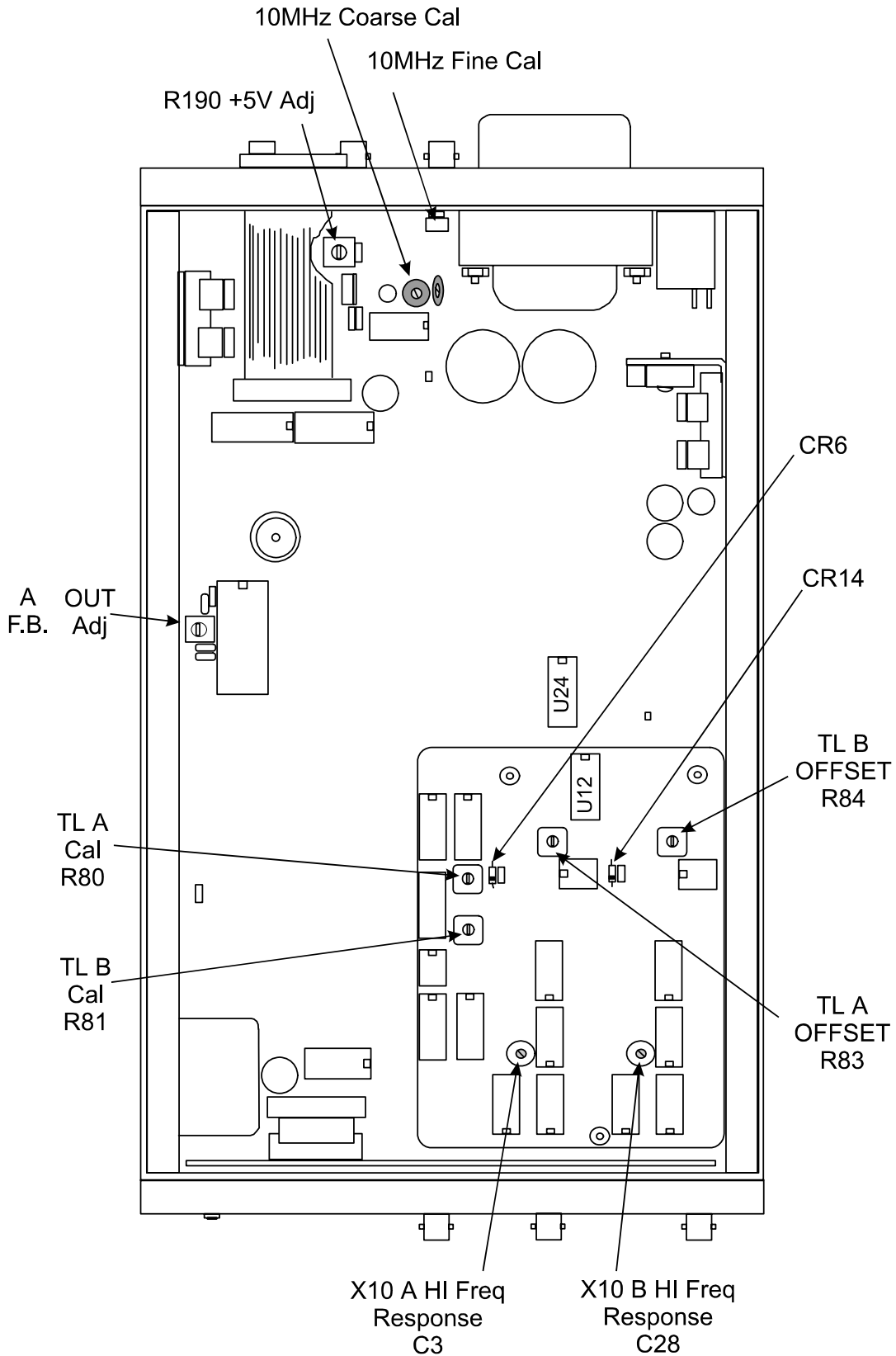

Figure 6-1 Model 2201 Adjustment Point Locations

TRIGGER LEVEL B ADJUSTMENT



Equipment: DMM, DC voltage calibrator

Procedure:

1. Set DMM to DCV measurements.
2. Set **[TL B]** to 0.00 V.
3. Measure and record the voltage at U12 pin 9. Record this voltage with a resolution of ± 0.001 V.
4. Set **[TL B]** to 5.00 V.
5. Set DC calibrator output setting to +5.000 V.
6. Using a banana to BNC adapter, connect the calibrator output to the Channel B input connector.
7. Re-connect the DMM probes to U12 pin 9 and adjust R81 to obtain the same voltage level as recorded in step 3.

TRIGGER LEVEL A OFFSET ADJUSTMENT



Equipment: Function generator, oscilloscope

Procedure:

1. Set function generator controls as follows:
 - Waveform - Sine
 - Frequency - 1 KHz
 - Amplitude - 25 mVp-p
 - Offset - 0 V
 - Symmetry - 50%
2. Press Model 2201 buttons in the following sequence: **[2nd],[DCL]** and then **[AC A]**.
3. Connect the function generator output to the Channel A input connector.
4. Set oscilloscope time base to 0.1 ms per division.
5. Connect the oscilloscope probe to U24 pin 9. Connect the ground lead from the probe to ground.
6. Adjust R83 to obtain a square wave having a 50% $\pm 1\%$ duty cycle on the oscilloscope.

TRIGGER LEVEL B OFFSET ADJUSTMENT



Equipment: Function generator, oscilloscope

Procedure:

1. Set function generator controls as follows:
 - Waveform - Sine
 - Frequency - 1KHz
 - Amplitude - 25mVp-p
 - Offset - 0 V
 - Symmetry - 50%
2. Press Model 2201 buttons in the following sequence: **[2nd]**, **[DCL]**, **[FREQ B]**, and then **[AC B]**.
3. Connect the function generator output to the Channel B input connector.
4. Set oscilloscope time base to 0.1 ms per division.
5. Connect the oscilloscope probe to U24 pin 14. Connect the ground lead from the probe to ground.
6. Adjust R84 to obtain a square wave having a 50% \pm 1% duty cycle on the oscilloscope.

INPUT A x10 HIGH FREQUENCY ADJUSTMENT



Equipment: Function generator, oscilloscope

Procedure:

1. Set function generator controls as follows:
 - Waveform - Square wave
 - Frequency - 10kHz
 - Amplitude - 5Vp-p
 - Offset - 0 V
 - Symmetry - 50%
2. Press Model 2201 buttons in the following sequence: **[2nd]**, **[DCL]**, **[50Ω A]** and then **[x10 A]**.
3. Connect the function generator output to the Channel A input connector.
4. Connect the oscilloscope probe to the cathode of CR6. Connect the ground lead from the probe to ground.
5. Set oscilloscope and adjust C3 to obtain the best square wave response having minimum overshoot and undershoot.

INPUT B x10 HIGH FREQUENCY ADJUSTMENT



Equipment: Function generator, oscilloscope

Procedure:

1. Set function generator controls as follows:
 - Waveform - Square wave
 - Frequency - 10kHz
 - Amplitude - 5Vp-p
 - Offset - 0 V
 - Symmetry - 50%
2. Press Model 2201 buttons in the following sequence: **[2nd]**, **[DCL]**, **[FREQ B]**, **[50Ω B]** and then **[x10 B]**.
3. Connect the function generator output to the Channel B input connector.
4. Connect the oscilloscope probe to the cathode of CR14. Connect the ground lead from the probe to ground.
5. Set oscilloscope and adjust C28 to obtain the best square wave response having minimum overshoot and undershoot.

TCXO TIME BASE ADJUSTMENT



Equipment: 10 MHz Standard

Procedure:

1. The following adjustment must be performed in a stable temperature environment of $25^{\circ}\text{C} \pm 2^{\circ}\text{C}$. Remove the top cover, refer to **Figure 5-1** and remove the adjustment plug at the top of the oscillator bulk. Replace the top cover. Power-up Model 2201 and allow it to operate, for at least an hour, with its covers closed.
2. Press Model 2201 buttons in the following sequence: **[2nd]**, **[DCL]** and then **[50Ω A]**.
3. Connect the 10 MHz standard to the Model 2201 Channel A.
4. Remove the top cover and using a plastic-tip screwdriver, adjust the trimming capacitor on top of the TCXO to give a reading of $10.0000000 \text{ E}+6 \pm 10 \text{ LSD}$
5. Replace the adjustment plug and the top cover and allow the Model 2201 to operate with the covers on for an additional period of 15 minutes.

6. Check if frequency is still in the range as in step 4. If reading shifted, repeat steps 4 through 6.

ANALOG OUTPUT ADJUSTMENT (Option 08)

Equipment: DMM

Procedure:

1. Using a BNC cable, connect the 10 MHz reference signal from the rear panel to Channel A input connector.
2. Press Model 2201 buttons in the following sequence: **[2nd]**, **[DCL]**, **[50 Ω]**, **[AC A]**, **[2nd]** and then **[A OUT]**.
3. Use the VERNIER UP bush-button to select the following reading on the display: (Refer to Chapter 3 for details).

10.0 _ _ _ _ _

4. Press **[2nd]** and then **[OFST]** buttons.
5. Use the VERNIER UP bush-button to modify the offset to 800. (Refer to Chapter 3 for details).
6. Set the DMM to DCV measurements. Connect the DMM probes through a banana to BNC adapter to the rear panel ANALOG OUTPUT BNC connector.
7. Adjust R168 for a DMM reading as follows:

9.000V ±0.001V



Chapter 7

PRODUCT SUPPORT

Product Support

Racal Instruments has a complete Service and Parts Department. If you need technical assistance or should it be necessary to return your product for repair or calibration, call 1-800-722-3262. If parts are required to repair the product at your facility, call 1-949-859-8999 and ask for the Parts Department.

When sending your instrument in for repair, complete the form in the back of this manual.

For worldwide support and the office closes to your facility, refer to the Support Offices section on the following page.

Reshipment Instructions

Use the original packing material when returning the 2201 to Racal Instruments for calibration or servicing. The original shipping crate and associated packaging material will provide the necessary protection for safe reshipment.

If the original packing material is unavailable, contact Racal Instruments Customer Service for information.

Support Offices

RACAL INSTRUMENTS

United States

(Corporate Headquarters and Service Center)
4 Goodyear Street, Irvine, CA 92618
Tel: (800) 722-2528, (949) 859-8999; Fax: (949) 859-7139

5730 Northwest Parkway Suite 700, San Antonio, TX 78249
Tel: (210) 699-6799; Fax: (210) 699-8857

Europe

(European Headquarters and Service Center)
18 Avenue Dutartre, 78150 LeChesnay, France
Tel: +33 (0)1 39 23 22 22; Fax: +33 (0)1 39 23 22 25

29-31 Cobham Road, Wimborne, Dorset BH21 7PF, United Kingdom
Tel: +44 (0) 1202 872800; Fax: +44 (0) 1202 870810

Via Milazzo 25, 20092 Cinisello B, Milan, Italy
Tel: +39 (0)2 6123 901; Fax: +39 (0)2 6129 3606

Racal Instruments Group Limited, Technologie Park,
D-51429 Bergisch Gladbach
Tel: +49 2204 844205; Fax: +49 2204 844219

REPAIR AND CALIBRATION REQUEST FORM

To allow us to better understand your repair requests, we suggest you use the following outline when calling and include a copy with your instrument to be sent to the Racal Instruments Repair Facility.

Model _____ Serial No. _____ Date _____

Company Name _____ Purchase Order # _____

Billing Address _____
City _____

State/Province _____ Zip/Postal Code _____ Country _____

Shipping Address _____
City _____

State/Province _____ Zip/Postal Code _____ Country _____

Technical Contact _____ Phone Number () _____

Purchasing Contact _____ Phone Number () _____

1. Describe, in detail, the problem and symptoms you are having. Please include all set up details, such as input/output levels, frequencies, waveform details, etc.

2. If problem is occurring when unit is in remote, please list the program strings used and the controller type.

3. Please give any additional information you feel would be beneficial in facilitating a faster repair time (i.e., modifications, etc.)

4. Is calibration data required? Yes No (please circle one)

Call before shipping Ship instruments to nearest support office
Note: We do not accept listed on back.
"collect" shipments. - 7-3 -

This page was left intentionally blank.

MODEL 2201 SPECIFICATIONS

Input Characteristics (Channels A and B)

Range

DC coupled		0 to 225 MHz
AC coupled		
	1M Ω	30 Hz to 225 MHz
	50 Ω	1 MHz to 225MHz

Sensitivity (X1)

35 mV rms sine wave	0 to 100 MHz
50 mV rms sine wave	100 MHz to 225 MHz
100 mV p-p	5 ns min pulse width

Signal operating Range

X1	-5.00 Vdc to +5.00 Vdc
X10	-50.0 Vdc to +50.0 Vdc

Dynamic Range (x1)

100 mV - 5 Vp-p	0 to 100 MHz
150 mV - 2.5 Vp-p	100 MHz to 225 MHz

Coupling AC or DC, switchable

Impedance 1 M Ω or 50 Ω nominal shunted by less than 45 pF, switchable

Slope Independent selection of + or - slope, switchable

Low Pass Filter -3db nominal at 100 KHz, switchable

Damage Level (AC or DC)

50 Ω	5 V rms
1 M Ω (X1)	DC to 2 kHz - 200 V (DC + peak AC)
	2 KHz to 100 KHz - 4 x 10E5 V rms
	Hz/Freq. Above 100 KHz - 5 V rms

1 M Ω (X10)	DC to 20 kHz - 200 V (DC + peak AC)
	20 KHz to 100 KHz - 4x10E6 V rms
	Hz/Freq. Above 100KHz - 50 V rms

Manual Attenuator X1 or X10 nominal, switchable

Auto Trigger Level Characteristics (Channels A and B)

Trigger Level Range

(automatic mode) -50.0 Vdc to +50.0 Vdc

Frequency Range

DC coupled 100 Hz to 150 MHz (typically 225 MHz)

AC coupled

1 M Ω 100 Hz to 150 MHz (typically 225 MHz)

50 Ω 1 MHz to 150 MHz (typically 225 MHz)

Notes:

1. Auto trigger is disabled in the following functions: Totalize B and Frequency C.
2. Auto trigger function requires that a repetitive signal be present at the input connector.

Auto Attenuation

Mode	Automatically enabled with the Auto Trigger.
x10 attenuator	Automatically enabled when either peak is greater than ± 5.1 V or when the difference between maximum and minimum peaks exceeds 5.1 V.
Minimum amplitude	100 mV rms sine wave, 280 mV p-p

Manual Trigger Level Characteristics (Channel A and B)

Range

(X1) -5.00 Vdc to +5.00 Vdc

(X10) -50.0 Vdc to +50.0 Vdc

Preset

(X1) 0.00 Vdc

(X10) 00.0 Vdc

Resolution

(X1) 10 mV

(X10) 100 mV

Setting Accuracy

(X1) \pm (35 mV +3% of the reading)

(X10) \pm (350 mV +3% of the reading)

Frequency A, B

Mode Reciprocal below 10 MHz and when EXT GATE mode or HOLD mode are selected. Conventional above 10MHz. The instrument automatically selects mode of operation. (10 MHz above changes to 100 MHz with opt 1)

Reciprocal Frequency Measurement Characteristics

Range 0.1 Hz to 125 MHz (see mode above).

LSD⁽¹⁾ Displayed $\frac{4 \times 10 \text{ ns} \times \text{frequency}}{\text{gate time}}$
e.g. min 8 digits in one second of gate time

Resolution $\frac{\pm \text{LSD} \pm (1.4 \times \text{Trig error}^{(2)} + 2 \text{ ns}) \times \text{Freq}}{\text{gate time}}$

Accuracy $\pm \text{resolution} \pm \text{Time Base Error}^{(3)} \times \text{Freq}$

Conventional Frequency Measurement Characteristics

Range 10 MHz to 225 MHz
with option 1 installed 100 MHz to 225 MHz

LSD⁽¹⁾ Displayed $\frac{4}{\text{gate time}}$

Resolution $\pm 1 \text{ LSD}$

Accuracy $\pm 1 \text{ LSD} \pm \text{Time Base error}^{(3)} \times \text{Freq}$

Frequency C (available with option 41 only)

Mode Reciprocal mode only

Range 50 MHz to 1300 MHz

LSD⁽¹⁾ Displayed Same as for Frequency A and B

Resolution Same as for Frequency A and B

Accuracy Same as for Frequency A and B

Period A, Pulse A, Time Interval A to B

Range 10 ns to 10e4 s

LSD⁽¹⁾ Displayed 10 ns for time less than 10 s
5 e-9 x time for time more than 10 s

Resolution $\pm 1 \text{ LSD} \pm \text{start trig error}^{(2)} \pm \text{stop trig error}^{(2)}$

Accuracy $\pm \text{resolution} \pm (\text{Time Base error}^{(3)} \times \text{Time})$
 $\pm \text{Trig level timing error}^{(4)} \pm 2 \text{ ns}$

Period A - Averaged*

Range 8 ns to 10 s

LSD⁽¹⁾ Displayed $\frac{4 \times 10 \text{ ns} \times \text{Period}}{\text{gate time}}$

e.g. min 8 digits in 1 second of gate time

Resolution	$\pm \text{LSD} \pm \frac{(1.4 \times \text{Trig error}^{(2)} + 2 \text{ ns}) \times \text{Period}}{\text{gate time}}$
Accuracy	$\pm \text{resolution} \pm \text{Time Base error}^{(3)} \times \text{Period}$
Number of Periods Averaged	$N = \frac{\text{gate time}}{\text{Period}}$

Pulse A, Time Interval A to B - Averaged*

Range	
Pulse A	5 ns to 10 s
T.I A to B	0 ns to 10 s. A and B signals must have the same repetition rate.
LSD ⁽¹⁾ Displayed	$\frac{5 \times 10 \text{ ns}}{\sqrt{N}}$
Resolution	$\pm 1 \text{ LSD}$
Accuracy	$\frac{\pm \text{resolution} \pm \text{Trig error}^{(2)} \pm \text{Time Base error}^{(3)} \times \text{Time} \pm 2 \text{ ns}}{\sqrt{N}}$
Dead Time Stop to Start	20 ns minimum
Number of Samples Averaged	$N = \text{gate time} \times \text{Frequency A}$

Phase A to B - Averaged*

Range	0 to 360° x (1 - 20 ns x Freq A). example: 0 to 359.99° at 1 KHz 0 to 180.0° at 25 MHz
Frequency Range	0.1 Hz to 25 MHz. A and B signals must have the same frequency.
LSD ⁽¹⁾ Displayed	$\frac{2.5 \times 10 \text{ ns} \times 360^\circ \times (1 + \sqrt{N})}{\text{gate time}}$ or 0.01°, whichever is greater
Resolution	$\pm 1 \text{ LSD}$
Accuracy	$\frac{\pm \text{resolution} \pm 2 \text{ ns} \times \text{Freq A} \times 360^\circ \pm \text{Trigger error}^{(2)} \times \text{Freq A} \times 360^\circ}{\sqrt{N}}$
Number of Cycles Averaged	$N = \text{gate time} \times \text{Frequency A}$
Minimum Amplitude	100 mV rms sine wave

*In Averaged measurements, no phase relationship is allowed between the external source to the instrument's Time Base.

Totalize B

Gate Modes*

Infinite	Totalizing on B indefinitely
Totalize by A	Totalizing on B during pulse duration on A
Totalize by AA	Totalizing on B between a pair of two consecutive transitions of the same direction on A
Range	0 to 10e16 - 1
Frequency range	0 to 100 MHz
Dead Time Stop to Start ⁽⁷⁾	20 ns minimum between stop transition to the next start transition
LSD displayed	1 count of channel B input signal
Resolution	1 LSD
Accuracy	
Infinite	Absolute
Totalize by A	$\pm \text{pulse rep rate B} \times \text{Trig}^{(2)} \text{ error A}$ total counts B
Totalize by AA	Same as for Totalize by A

*Polarity of gate transition is front panel selectable.

Ratio A/B

Frequency Range

A	0.1 Hz to 225 MHz
B	0.1 Hz to 125 MHz

LSD ⁽¹⁾ displayed	$\frac{4 \times \text{Ratio}}{\text{Freq A} \times \text{gate time}}$
------------------------------	---

Resolution	$\frac{\pm \text{LSD} \pm \text{Trig error B}^{(2)} \times \text{Ratio}}{\text{gate time}}$
------------	---

Accuracy	Same as resolution
----------	--------------------

V Peak A

Operation Maximum and minimum peaks of Channel A input signal are simultaneously displayed, each with 3 digits. Decimal points and polarity are automatically displayed.

Frequency range

@ Fast rate	100 Hz to 10 MHz
@ Slow rate	40 Hz to 10 MHz

Dynamic range 280 mV p-p to 51 V p-p

Resolution

x1	10 mV
x10	100 mV. Attenuator is automatically activated if either the positive or the negative peaks of the input signal exceeds $\pm 5.1\text{V}$ or when the peak to peak voltage exceeds 5.1V.

Accuracy	\pm resolution $\pm 0.1(V_{\text{pos pk}} - V_{\text{neg pk}}) \pm 35\text{mV}$
Delay	
Operation	Active only with Time Measurements first input transition opens the gate. Delay inhibits the consequent transitions.
Modes	Internal through front panel programming or externally applied through rear panel BNC.
Internal range	100 μs to 10 s
Preset position	1 s
External range	100 μs to 10e4 s

Gate Time

Modes	Internal through front panel programming or externally applied through rear panel BNC.
Internal range	100 μ to 10 s or one period of the input.
External range	100 μs to 1000 s. Ext gate not available with Time measurements, Totalize and TI A to B
Preset position	1 s
External gate delay ⁽⁶⁾	< 10 μs

External Arming (Trigger)

Operation	Arms the instrument when set to HOLD mode.
Trigger Delay ⁽⁵⁾	< 50 μs
Minimum Pulse width	10 μs

External Input - Gate, Delay, and Arming

Input	TTL levels, via rear panel BNC
Input Impedance	1 K Ω nominal
Logic	Positive true

Time Base

Frequency	10 MHz
Aging Rate	<0.1 ppm / month
Stability	<1 ppm, 0 to 40 °C
Line Voltage	0.1 ppm for 10% change (short term)
Clock IN/OUT	Selected with an internal switch
External Time Base Input	Rear Panel BNC accepts 1, 5 or 10 MHz TTL. Selected via an internal switch.
Time Base Out	10 MHz >2 V
GPIB Interface	
Programmable Controls	All front panel controls except POWER switch
Multiline Commands	DCL, LLO, SDC, GET, GTL, UNT, UNL, SPE, SPD

Uniline Commands	IFC, REN, EOI, SRQ, ATN
Interface Functions	SH1, AH1, T6, TE0, L4, LE0, SR1, RL1, PP0, DC1, DT1, C0, E1
	Data Output Format Reading With prefix 18 ASCII characters plus terminator. Without prefix - 14 ASCII characters plus terminator
	Gate/Delay time and trigger level With prefix - 9 ASCII characters plus terminator or. Without prefix - 5 ASCII characters plus terminator
Address selection	Front panel controls. Address is stored in a non-volatile memory.

General

Display Rate	Normal- Approximately four measurements per second.
Hold	Single shot measurement, one measurement taken with each press of the RESET button.
Fast	Approximately 27 measurements per second.
Arming	Each channel is armed by it's own signal
Reset	Clears front panel display and begins a new measurement cycle.
Trigger Level Outputs	DC Outputs via rear panel terminals, not adjusted for attenuator.
Accuracy	DC (X1) ± 50 mV $\pm 5\%$ of trigger level reading.
Output impedance	1 K Ω 1%
Display	9 digits seven segments LED 0.56" high. 2 digits for engineering notations. Operator may select through front panel programming the number of digits to be displayed. Selection may range from 9 to 3 most significant digits.
Decimal Point	Automatically selected.
Gate	LED indicator lights when gate is open.
Set-ups	Ten measurement set-ups, including trigger levels, gate/delay time, input conditioning and measurement rate may be stored in memory and subsequently recalled. When AC mains power is removed, a non-volatile memory will preserve the stored setups for a typical period of 5 years.
Operating Temperature	0 to 40 °C ambient, 0 to 80% relative humidity
Storage temperature	-25 to 65 °C
Power Requirements	115/230V rms $\pm 10\%$ 48-63 Hz, 40 W max
Voltage Range Selection	Rear panel switch
Warm-up	1 hour to rated accuracy and stability
Dimensions	87 x 210 x 390 (H x W x D)
Weight	approximately 4 kg
EMC	CE marked
Reliability	MTBF per MIL-HDBK-217E, 25 °C, Ground Benign
Safety	Designed to meet IEC 1010-1, UL 3111-1, CSA 22.2 #1010
Workmanship Standards	Conform to IPC-A-610D
Accessories Furnished	Power Cord, Operating Manual

Options

Option 11 - OCXO

Frequency	10 MHz
Accuracy	0.01ppm
Aging Rate	<0.1 ppm/year
Stability	<0.1 ppm, 0 to 60 °C
Warm-up Time	0.1 ppm in 3 minutes
Clock IN/OUT	Selected with an internal switch
External Time Base Input	Rear Panel BNC accepts 1, 5 or 10 MHz TTL. Selected via an internal switch.
Time Base Out	10 MHz >2 V

Option 12 - Rubidium

Short Term Stability	(10-100s): 1×10^{-11}
Long Term Stability	(1 month): 5×10^{-11}
Phase Noise	(1kHz offset, 1 Hz BW): -140dB
Retrace	(off 24hrs, 1hr warm-up): 5×10^{-11}
Retrace	(24hr warm-up): 2×10^{-11}
Rear Panel Outputs:	2

Option 41 - Frequency C to 1.3 GHz

Range	50 MHz to 1.3 GHz
Sensitivity	25 mV rms to 1.0 GHz; 50 mV rms to 1.3 GHz
Input Impedance	50Ω nominal
Dynamic Range	25 mV to 1 V rms up to 1.0 GHz; 50 mV to 1 V rms up to 1.3 GHz
Coupling	AC
Damage Level	DC to 100 KHz - 15 V (DC + peak AC) 100 KHz to 1.3 GHz - 5 Vrms

Option 8 - Analog Output

Operation	Digital to analog converter, provides a high resolution analog output of any three consecutive digits
Decade conversion	Any 3 consecutive digits can be selected via front panel programming.
Normal mode	Output is directly proportional to display reading. 000 produces 0.00 Vdc. 999 produces 9.99 Vdc.
Offset Mode	Front panel programmed. Adds an offset to obtain analog recorder scale offset.
Offset range	0 to 9.00 Vdc in 1 V increments.

Output	Rear panel BNC connector
Full scale deflection	9.99 Vdc
Accuracy	±2 mV
Output impedance	1 KΩ 1%
Non-linearity	±2mV
Settling time	<1 ms after measurement has been completed.

Definition of Terms

- (1) LSD Unit value of least significant digit. Calculation should be rounded as follows 1 to <5 Hz becomes 1 Hz, 5 ns to <10 ns becomes 10 ns etc.
- (2) Trigger Error
$$\frac{\sqrt{(e_i^2 + e_n^2)}}{\text{Input slew rate at trigger point}} \quad \text{seconds rms}$$
Where: e_i is the rms noise voltage of the counter's input channel (250 μ V typically)
 e_n is the rms noise of the input signal for 225 MHz bandwidth
- (3) Time base error Maximum fractional frequency change in time base frequency due to all errors: e.g. aging, temperature, line voltage etc.
- (4) Trigger Level Timing Error (x1)
$$\pm \frac{18 \text{ mV}}{|\text{Input slew rate at start}|} \quad \pm \frac{18 \text{ mV}}{|\text{Input slew rate at stop}|}$$
$$\left| \begin{array}{c} \text{trigger point} \\ | \end{array} \right| \quad \left| \begin{array}{c} \text{trigger point} \\ | \end{array} \right|$$
- (5) External arming (trigger) delay Delay from the positive going slope of the arming signal to the internal gate open signal.
- (6) External gate delay Delay from the positive going slope of the gating signal to the internal gate open signal.
- (7) Dead Time Minimum time between measurement which the counter is busy in performing the measurement. The counter will not at this time respond to any input transition.

This page was left intentionally blank.